

# Wirówki laboratoryjne

## Laboratory centrifuges

	<i>pl</i>	<i>en</i>
11	- WIRNIKI KĄTOWE	ANGLE ROTORS
12	- WIRNIKI HORYZONTALNE	SWING-OUT ROTORS
13	- POJEMNIKI	BUCKETS
14	- WKŁADKI	INSERTS
15	- PROBÓWKI	TUBES





54



55



56



215



223 a/b/c/e/es



**251**



**351e**



**260/R/RH**









**352/R/RH**

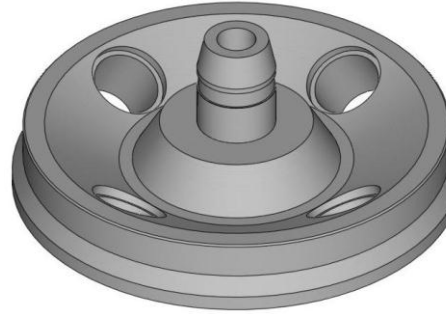

**380/R**

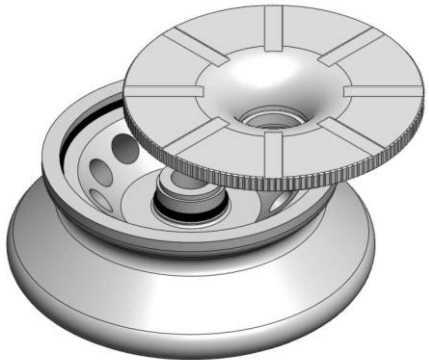
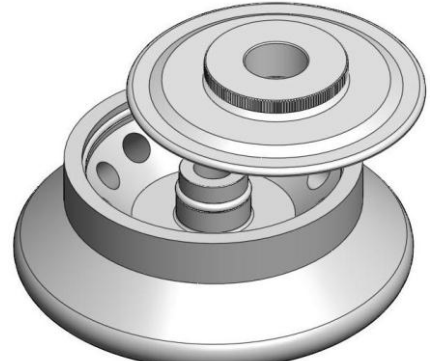
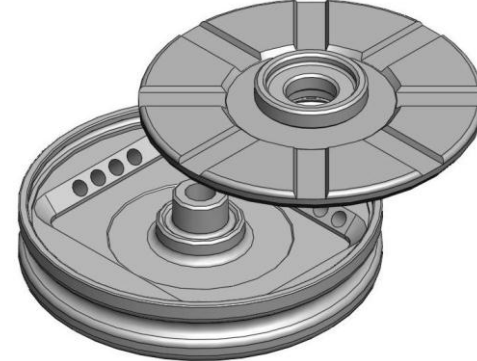
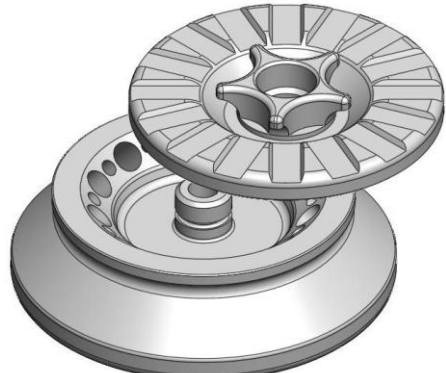
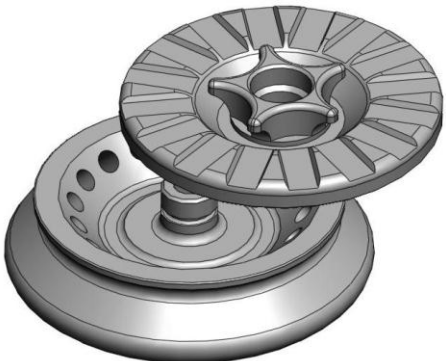
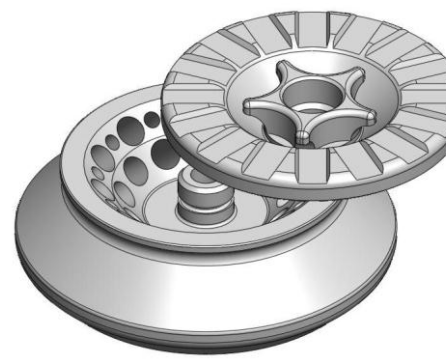
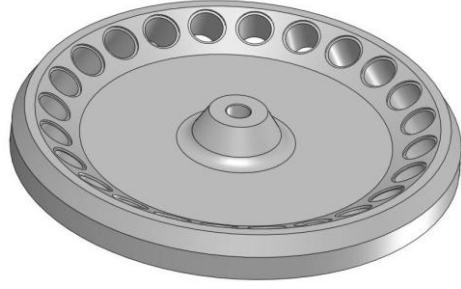
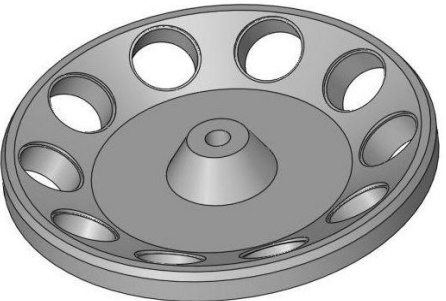









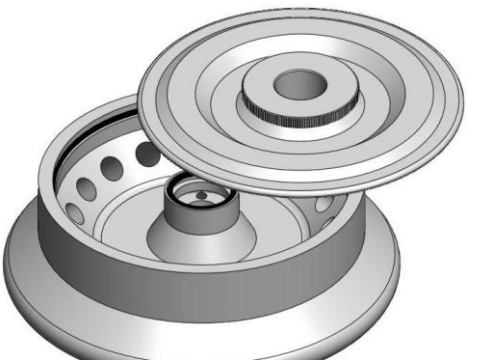

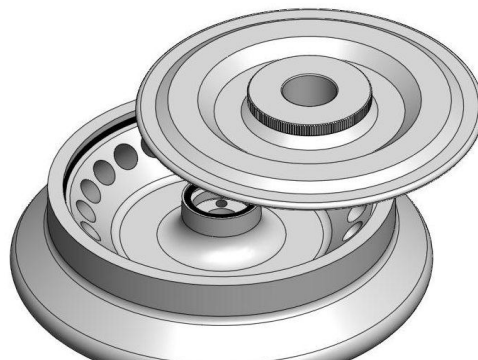
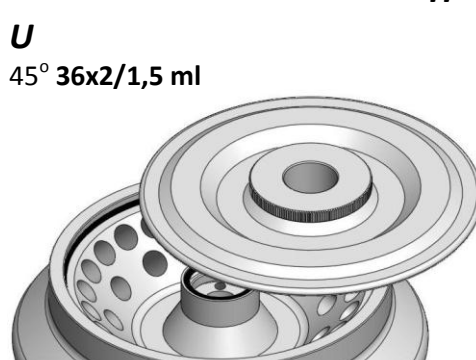
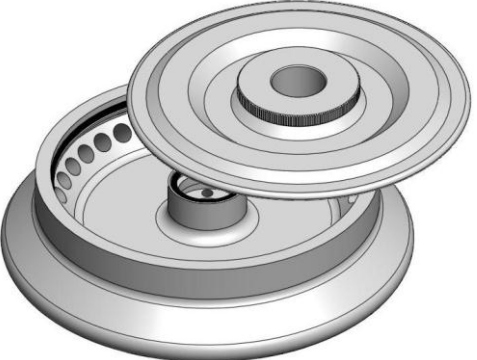
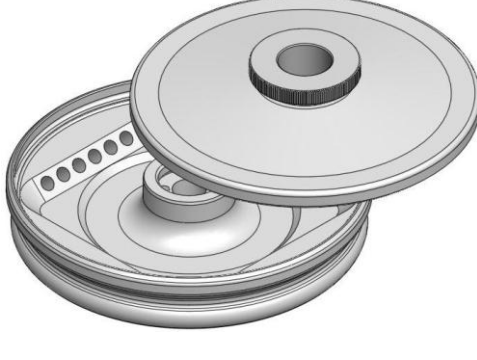
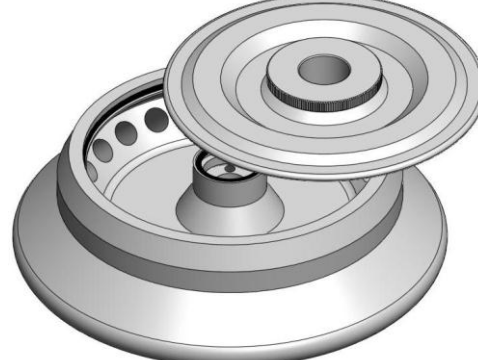
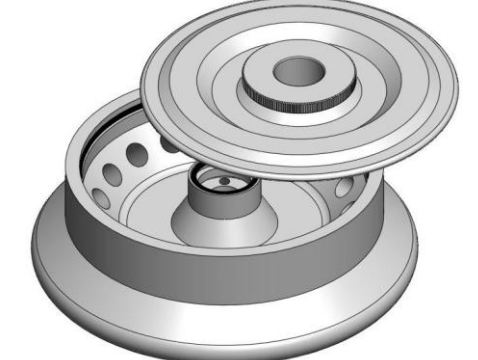
<p><b>11101</b> 30° 6x15/10 ml</p>  <p>Wirówka/Centrifuge: <b>MPW-54</b> Pojemnik/Bucket: <b>13080, 13081</b> <math>R_{max} = 8,3</math> cm 5800 rpm, 3120 RCF</p>	<p><b>11140</b> 30° 6x15/10 ml</p>  <p>Wirówka/Centrifuge: <b>MPW-56</b> Pojemnik/Bucket: <b>13080, 13081</b> <math>R_{max} = 8,3</math> cm 6000 rpm, 3340 RCF</p>	<p><b>11141</b> 30° 8x15/10 ml</p>  <p>Wirówka/Centrifuge: <b>MPW-56</b> Pojemnik/Bucket: <b>13080, 13081</b> <math>R_{max} = 8,3</math> cm 6000 rpm, 3340 RCF</p>	<p><b>11144</b> 30° 4x10/15 ml</p>  <p>Wirówka/Centrifuge: <b>MPW-54</b> Pojemnik/Bucket: <b>13080, 13081</b> <math>R_{max} = 8,3</math> cm 5800 rpm, 3120 RCF</p>	<p><b>11145</b> 30° 8x15/10 ml</p>  <p>Wirówka/Centrifuge: <b>MPW-54</b> Pojemnik/Bucket: <b>13080, 13081</b> <math>R_{max} = 8,3</math> cm 5800 rpm, 3120 RCF</p>	<p><b>11198</b> <i>HU</i> 45° 12x2/1,5 ml</p>  <p>Wirówka/Centrifuge: <b>MPW-215</b> Wkładka/Adaptor: <b>14084, 14126, 14133</b> <math>R_{max} = 6,1</math> cm 13000 rpm, 11500 RCF</p>
<p><b>11199</b> <i>HU</i> 45° 12x2/1,5 ml</p>  <p>Wirówka/Centrifuge: <b>MPW-251,260, 351,352</b> Wkładka/Adaptor: <b>14084, 14126, 14133</b> <math>R_{max} = 6,65</math> cm 18000 rpm, 24088 RCF</p>	<p><b>11201</b> <i>HU</i> 45° 2x8, 2x4 x0,2PCR</p>  <p>Wirówka/Centrifuge: <b>MPW-55, 56</b> <math>R_{max} = 5,6</math> cm 14500 rpm, 13163 RCF</p>	<p><b>11202</b> <i>HU</i> 45° 12x2/1,5 ml</p>  <p>Wirówka/Centrifuge: <b>MPW-55, 56</b> Wkładka/Adaptor: <b>14084, 14133</b> <math>R_{max} = 6,5</math> cm 14500 rpm, 15279 RCF</p>	<p><b>11203</b> <i>HU</i> 45° 18x0,5 ml</p>  <p>Wirówka/Centrifuge: <b>MPW-55, 56</b> Wkładka/Adaptor: <b>14134</b> <math>R_{max} = 5,9</math> cm 14500 rpm, 13868 RCF</p>	<p><b>11204</b> <i>HU</i> 45° 24x2/1,5 ml</p>  <p>Wirówka/Centrifuge: <b>MPW-55, 56</b> Wkładka/Adaptor: <b>14084, 14133</b> <math>R_{max} = 6,5</math> cm 14500 rpm, 15279 RCF</p>	<p><b>11210</b> 30° 24x15/10 ml</p>  <p>Wirówka/Centrifuge: <b>MPW-351,352, 351e</b> Pojemnik/Bucket: <b>13080, 13081</b> <math>R_{max} = 14,3</math> cm 5000 rpm, 3996 RCF</p>
<p><b>11211</b> 30° 10x50 ml Falcon</p>  <p>Wirówka/Centrifuge: <b>MPW-351,352, (351e po wyczerpaniu 11254)</b> Pojemnik/Bucket: <b>13275, 13276</b> <math>R_{max} = 13,3</math> cm 5500 rpm, 4498 RCF</p>	<p><b>11213</b> 30° 8x50 ml Falcon</p>  <p>Wirówka/Centrifuge: <b>MPW- 251, 260, 351,352</b> Pojemnik/Bucket: <b>13275, 13276</b> <math>R_{max} = 12,5</math> cm; 5500 rpm, 4227 RCF</p>				

<p><b>11215</b> 45° 32x15/10 ml</p>  <p>Wirówka/Centrifuge: <b>MPW-351e</b> Pojemnik/Bucket: <b>13080, 13081</b> R<sub>max</sub> = <b>14,5 cm</b> <b>4500 rpm, 3283 RCF</b></p>	<p><b>11216</b> <i>HU</i> 45° 12x5 ml</p>  <p>Wirówka/Centrifuge: <b>MPW-251, 260</b> R<sub>max</sub> = <b>8,7 cm</b> <b>14000 rpm, 19064 RCF</b></p>	<p><b>11217</b> 30° 10x10/15 ml</p>  <p>Wirówka/Centrifuge: <b>MPW-251, 260</b> Pojemnik/Bucket: <b>13080, 13081</b> R<sub>max</sub> = <b>10,5 cm</b> <b>6000 rpm, 4226 RCF</b></p>	<p><b>11237</b> 30° 12x15/10 ml</p>  <p>Wirówka/Centrifuge: <b>MPW-223e, es</b> Pojemnik/Bucket: <b>13080, 13081</b> R<sub>max</sub> = <b>11,9 cm</b> <b>5000 rpm, 3326 RCF</b></p>	<p><b>11254</b> 30° 10x50 ml Falcon</p>  <p>Wirówka/Centrifuge: <b>MPW-351e</b> Pojemnik/Bucket: <b>13275, 13276</b> R<sub>max</sub> = <b>13,3 cm</b> <b>4500 rpm, 3011 RCF</b></p>	<p><b>11257</b> 45° 4x30/25 ml</p>  <p>Wirówka/Centrifuge: <b>MPW-223e, es</b> Pojemnik/Bucket: <b>13329</b> R<sub>max</sub> = <b>11,9 cm</b> <b>5000 rpm, 3326 RCF</b></p>
<p><b>11259</b> <i>HU</i> 45° 30x2/1,5 ml</p>  <p>Wirówka/Centrifuge: <b>MPW-351,352</b> Wkładka/Adaptor: <b>14084, 14126, 14133</b> R<sub>max</sub> = <b>9,7 cm</b> <b>15000 rpm, 24400 RCF</b></p>	<p><b>11273</b> <i>HU</i> 30° 8x30 ml</p>  <p>Wirówka/Centrifuge: <b>MPW-351,352</b> R<sub>max</sub> = <b>8,7 cm</b> <b>12000 rpm, 14000 RCF</b></p>	<p><b>11329</b> 30° 10x30/25 ml</p>  <p>Wirówka/Centrifuge: <b>MPW-223e</b> Pojemnik/Bucket: <b>13329</b> R<sub>max</sub> = <b>12 cm</b> <b>4000 rpm, 2146 RCF</b></p>	<p><b>11332</b> 30° 12x30/25 ml</p>  <p>Wirówka/Centrifuge: <b>MPW-223e</b> Pojemnik/Bucket: <b>13329</b> R<sub>max</sub> = <b>12 cm</b> <b>4000 rpm, 2146 RCF</b></p>	<p><b>11333</b> 30° 10x50 ml Falcon</p>  <p>Wirówka/Centrifuge: <b>MPW-223e</b> Pojemnik/Bucket: <b>13276</b> R<sub>max</sub> = <b>11,7 cm</b> <b>4000 rpm, 2092 RCF</b></p>	<p><b>11456</b> 30° 36x15/10 ml</p>  <p>Wirówka/Centrifuge: <b>MPW-351,352</b> Pojemnik/Bucket: <b>13080, 13081</b> R<sub>max</sub> = <b>14,3 cm</b> <b>5000 rpm, 3996 RCF</b></p>
<p><b>11457</b> <i>HU</i> 30° 6x50 ml Falcon</p>  <p>Wirówka/Centrifuge: <b>MPW-351,352</b> Wkładka/Adaptor: <b>14071, 14073, 14089</b> R<sub>max</sub> = <b>9,6 cm</b> <b>10000 rpm, 10732 RCF</b></p>	<p><b>11458</b> <i>HU</i> 30° 6x30 ml Nalgene</p>  <p>Wirówka/Centrifuge: <b>MPW-351,352</b> R<sub>max</sub> = <b>7,8 cm</b> <b>15000 rpm, 19621 RCF</b></p>	<p><b>11459</b> <i>HU</i> 30° 12x10 ml</p>  <p>Wirówka/Centrifuge: <b>MPW-351,352</b> Wkładka/Adaptor: <b>14149</b> R<sub>max</sub> = <b>8,5 cm</b> <b>15000 rpm, 21381 RCF</b></p>	<p><b>11460</b> <i>HU</i> 45° 36x0,5 ml</p>  <p>Wirówka/Centrifuge: <b>MPW-351,352</b> Wkładka/Adaptor: <b>14134</b> R<sub>max</sub> = <b>8,2 cm</b> <b>18000 rpm, 29703 RCF</b></p>	<p><b>11461</b> <i>HU</i> 45° 24x2/1,5 ml</p>  <p>Wirówka/Centrifuge: <b>MPW-251,260, 351</b> Wkładka/Adaptor: <b>14084, 14126, 14133</b> R<sub>max</sub> = <b>8,3 cm</b> <b>18000 rpm, 30065 RCF</b></p>	<p><b>11462</b> <i>HU</i> 45° 36x2/1,5 ml</p>  <p>Wirówka/Centrifuge: <b>MPW-251,260, 351</b> Wkładka/Adaptor: <b>14084, 14126, 14133</b> R<sub>max</sub> = <b>8,3 cm</b> <b>18000 rpm, 30065 RCF</b></p>

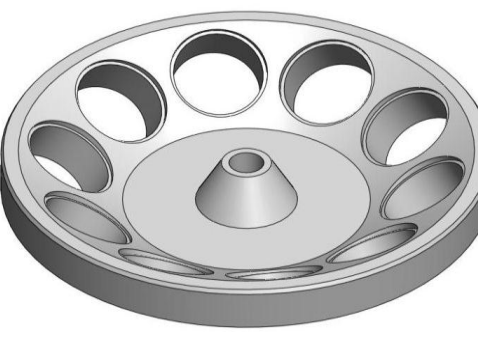
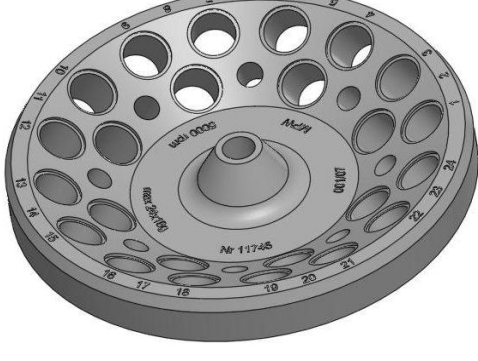

<p><b>11465</b> 30° 30x15/10 ml</p>  <p>Wirówka/Centrifuge: <b>MPW-351e, 351</b> Pojemnik/Bucket: <b>13080, 13081</b> R<sub>max</sub> = <b>13,3 cm</b> <b>5200 rpm, 4020 RCF</b></p>	<p><b>11466</b> <i>HU</i> 30° 10x15 ml Falcon</p>  <p>Wirówka/Centrifuge: <b>MPW-351,352</b> R<sub>max</sub> = <b>9,6 cm</b> <b>10000 rpm, 10732 RCF</b></p>	<p><b>11467</b> <i>HU</i> 30° 12x10 ml</p>  <p>Wirówka/Centrifuge: <b>MPW-351,352</b> R<sub>max</sub> = <b>9,4 cm</b> <b>12000 rpm, 15133 RCF</b></p>	<p><b>11468</b> <i>HU</i> 45° 6x8x0,2 ml - PCR</p>  <p>Wirówka/Centrifuge: <b>MPW-351,352</b> R<sub>max</sub> = <b>9,5 cm</b> <b>12000 rpm, 15294 RCF</b></p>	<p><b>11469</b> <i>HU</i> 30° 6x50 ml Nalgene</p>  <p>Wirówka/Centrifuge: <b>MPW-351,352</b> Wkładka/Adaptor: <b>14035, 14036</b> R<sub>max</sub> = <b>9,0 cm</b> <b>12000 rpm, 14490 RCF</b></p>	<p><b>11478</b> <i>HU</i> 45° 36x0,5 ml</p>  <p>Wirówka/Centrifuge: <b>MPW-215</b> Wkładka/Adaptor: <b>14134</b> R<sub>max</sub> = <b>8,2 cm</b> <b>13000 rpm, 15493 RCF</b></p>
<p><b>11486</b> 30° 24x15/10 ml</p>  <p>Wirówka/Centrifuge: <b>MPW-223e</b> Pojemnik/Bucket: <b>13080, 13081</b> R<sub>max</sub> = <b>11,7 cm</b> <b>4000 rpm, 2092 RCF</b></p>	<p><b>11487</b> 45° 8x15/10 ml</p>  <p>Wirówka/Centrifuge: <b>MPW-223e, es</b> Pojemnik/Bucket: <b>13080, 13081</b> R<sub>max</sub> = <b>11,5 cm</b> <b>5000 rpm, 3214 RCF</b></p>	<p><b>11496</b> <i>HU</i> 30° 4x85 ml i 4x30 ml Nalgene</p>  <p>Wirówka/Centrifuge: <b>MPW-351,352</b> R<sub>max</sub> = <b>9,5 cm</b> <b>10000 rpm, 10621 RCF</b></p>	<p><b>11501</b> kątowy/angle 30° 30x15/10 ml</p>  <p>Wirówka/Centrifuge: <b>MPW-251, 260, 351, 352</b> Pojemnik/Bucket: <b>13080, 13081</b> R<sub>max</sub> = <b>13,3 cm; 5200 rpm, 4020 RCF</b></p>	<p><b>11502</b> kątowy/angle 30° 30x15/10 ml</p>  <p>Wirówka/Centrifuge: <b>MPW-223e</b> Pojemnik/Bucket: <b>13080, 13081</b> R<sub>max</sub> = <b>13,3 cm</b> <b>4000 rpm, 2379 RCF</b></p>	<p><b>11503</b> kątowy/angle 40° 8x butelki/bottles Babcock (Gerber 5406)</p>  <p>Wirówka/Centrifuge: <b>MPW-351, 352</b> Pojemnik/Bucket: <b>13504</b> R<sub>max</sub> = <b>16,4 cm; 2000 rpm, 733 RCF</b></p>
<p><b>11585</b> <i>HU</i> 45° 12x8x0,2 ml PCR</p>  <p>Wirówka/Centrifuge: <b>MPW-351,352</b> R<sub>max</sub> = <b>9,5 cm</b> <b>14000 rpm, 20817 RCF</b></p>	<p><b>11586</b> 30° 6x85 ml Nalgene</p>  <p>Wirówka/Centrifuge: <b>MPW-351,352</b> Pojemnik/Bucket: <b>13587</b> R<sub>max</sub> = <b>11,1 cm</b> <b>7000 rpm, 6080 RCF</b></p>	<p><b>11715</b> <i>HU</i> 30° 10x10 ml (75 mm)</p>  <p>Wirówka/Centrifuge: <b>MPW-251, 260</b> R<sub>max</sub> = <b>7,1 cm</b> <b>14000 rpm, 15558 RCF</b></p>			

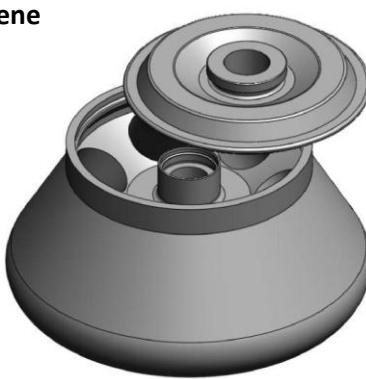

<p><b>11716</b> <span style="float: right;"><i>HU</i></span> 45° 4x8x0,2 ml</p>  <p>Wirówka/Centrifuge: <b>MPW-251, 260</b> R<sub>max</sub> = <b>7,0 cm</b> <b>14000 rpm, 15339 RCF</b></p>	<p><b>11717</b> <span style="float: right;"><i>HU</i></span> 45° 18x2 ml filtr</p>  <p>Wirówka/Centrifuge: <b>MPW-251, 260</b> Wkładka/Adaptor: <b>14084, 14126, 14133</b> R<sub>max</sub> = <b>8,3 cm</b> <b>14000 rpm, 18187 RCF</b></p>	<p><b>11718</b> 30° 4x100 ml</p>  <p>Wirówka/Centrifuge: <b>MPW-251,260, 351,352</b> Pojemnik/Bucket: <b>13719, 14192c</b> R<sub>max</sub> = <b>11,3 cm</b> <b>6300 rpm, 5014 RCF</b></p>	<p><b>11720</b> kątowy/angle 45° 4x60 ml Orthokin II</p>  <p>Wirówka/Centrifuge: <b>MPW-223es</b> Pojemnik/Bucket: <b>13721</b> R<sub>max</sub> = <b>13 cm</b> <b>5000 rpm, 3633 RCF</b></p>	<p><b>11731</b> <span style="float: right;"><i>HU</i></span> 45° 24x2/1,5 ml</p>  <p>Wirówka/Centrifuge: <b>MPW-65R, 215</b> Wkładka/Adaptor: <b>14084, 14126, 14133</b> R<sub>max</sub> = <b>8,3 cm</b> <b>14000 rpm, 18187 RCF</b></p>	<p><b>11732</b> <span style="float: right;"><i>H</i></span> <i>U</i> 45° 36x2/1,5 ml</p>  <p><b>14133</b> R<sub>max</sub> = <b>8,3 cm</b> <b>14000 rpm, 18187 RCF</b></p>
<p><b>11733</b> <span style="float: right;"><i>HU</i></span> 45° 36x0,5 ml</p>  <p>Wirówka/Centrifuge: <b>MPW-65R, 215</b> Wkładka/Adaptor: <b>14134</b> R<sub>max</sub> = <b>8,2 cm</b> <b>14000 rpm, 17968 RCF</b></p>	<p><b>11734</b> <span style="float: right;"><i>HU</i></span> 45° 4x8x0,2 ml PCR</p>  <p>Wirówka/Centrifuge: <b>MPW-65R, 215</b> R<sub>max</sub> = <b>7,0 cm</b> <b>14000 rpm, 15339 RCF</b></p>	<p><b>11735</b> <span style="float: right;"><i>HU</i></span> 45° 24x2 ml filtr</p>  <p>Wirówka/Centrifuge: <b>MPW-65R</b> Wkładka/Adaptor: <b>14084, 14126, 14133</b> R<sub>max</sub> = <b>9,2 cm</b> <b>14000 rpm, 20160 RCF</b></p>	<p><b>11738</b> <span style="float: right;"><i>HU</i></span> 45° 18x2 ml filtr</p>  <p>Wirówka/Centrifuge: <b>MPW-65R, 215</b> Wkładka/Adaptor: <b>14084, 14126, 14133</b> R<sub>max</sub> = <b>8,3 cm; 14000 rpm, 18187 RCF</b></p>	<p><b>11739</b> <span style="float: right;"><i>HU</i></span> 45° 24x2 ml filtr</p>  <p>Wirówka/Centrifuge: <b>MPW-351,352</b> Wkładka/Adaptor: <b>14084, 14126, 14133</b> R<sub>max</sub> = <b>9,2 cm</b> <b>15000 rpm, 23142 RCF</b></p>	<p><b>11740</b> 30° 12x15/10 ml</p>  <p>Wirówka/Centrifuge: <b>MPW-251, 260, 351,352</b> Pojemnik/Bucket: <b>13080, 13081</b> R<sub>max</sub> = <b>12 cm</b> <b>5500 rpm, 4058 RCF</b></p>
<p><b>11741</b> 30° 8x15/10 ml</p>  <p>Wirówka/Centrifuge: <b>MPW-251, 260, 351,352</b> Pojemnik/Bucket: <b>13080, 13081</b> R<sub>max</sub> = <b>10,5 cm</b> <b>6000 rpm, 4226 RCF</b></p>	<p><b>11742</b> 45° 4x30/25 ml</p>  <p>Wirówka/Centrifuge: <b>MPW-251, 260</b> Pojemnik/Bucket: <b>13329</b> R<sub>max</sub> = <b>12 cm</b> <b>6000 rpm, 4829 RCF</b></p>	<p><b>11743</b> 30° 12x30/25 ml</p>  <p>Wirówka/Centrifuge: <b>MPW-251, 260, 351e, 351,352</b> Pojemnik/Bucket: <b>13329</b> R<sub>max</sub> = <b>12 cm</b> <b>5500 rpm, 4058 RCF</b></p>	<p><b>11744</b> 30° 10x50 ml Falcon</p>  <p>Wirówka/Centrifuge: <b>MPW-251, 260</b> Pojemnik/Bucket: <b>13276</b> R<sub>max</sub> = <b>12,5 cm</b> <b>4500 rpm, 2830 RCF</b></p>	<p><b>11745</b> 30° 24x15/10 ml</p>  <p>Wirówka/Centrifuge: <b>MPW-251, 260</b> Pojemnik/Bucket: <b>13080, 13081</b> R<sub>max</sub> = <b>12 cm</b> <b>5000 rpm, 3354 RCF</b></p>	<p><b>11746</b> 30° 6x50 ml Falcon</p>  <p>Wirówka/Centrifuge: <b>MPW-251, 260, 351,352</b> Pojemnik/Bucket: <b>13276</b> R<sub>max</sub> = <b>11,0 cm</b> <b>6000 rpm, 4427 RCF</b></p>

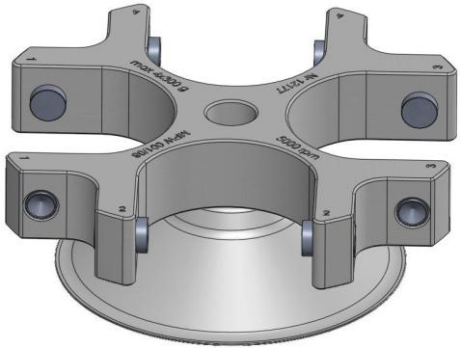
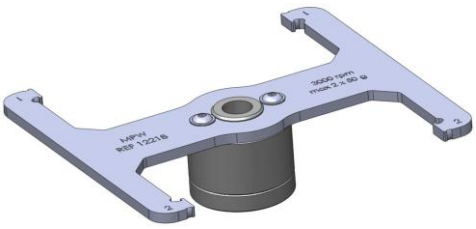
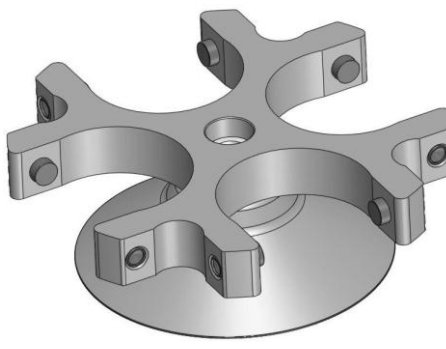
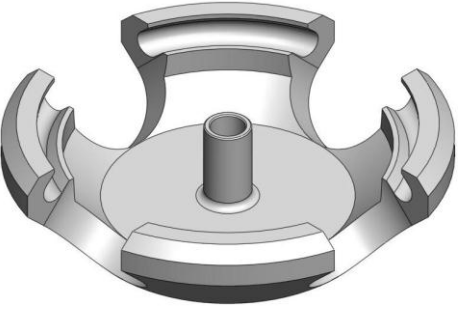
<p><b>11761</b> <span style="float: right;">HU</span> 45° 30x2/1,5 ml</p>  <p>Wirówka/Centrifuge: <b>MPW-380</b> Wkładka/Adaptor: <b>14084, 14126, 14133</b> R<sub>max</sub> = <b>9,7 cm</b> <b>16400 rpm, 29168 RCF</b></p>	<p><b>11762</b> <span style="float: right;">HU</span> 45° 36x2/1,5 ml</p>  <p>Wirówka/Centrifuge: <b>MPW-380</b> Wkładka/Adaptor: <b>14084, 14126, 14133</b> R<sub>max</sub> = <b>8,3 cm</b> <b>18000 rpm, 30065 RCF</b></p>	<p><b>11763</b> <span style="float: right;">HU</span> 45° 48x2/1,5 ml</p>  <p>Wirówka/Centrifuge: <b>MPW-380</b> Wkładka/Adaptor: <b>14084, 14126, 14133</b> R<sub>max</sub> = <b>9,4 cm</b> <b>16400 rpm, 28265 RCF</b></p>	<p><b>11765</b> <span style="float: right;">HU</span> 45° 12x8x0,2 ml PCR</p>  <p>Wirówka/Centrifuge: <b>MPW-380</b> R<sub>max</sub> = <b>9,5 cm</b> <b>16400 rpm, 28566 RCF</b></p>	<p><b>11766</b> <span style="float: right;">HU</span> 45° 12x10 ml/81mm</p>  <p>Wirówka/Centrifuge: <b>MPW-380</b> R<sub>max</sub> = <b>8,6 cm</b> <b>18000 rpm, 31150 RCF</b></p>	<p><b>11767</b> <span style="float: right;">HU</span> 30° 12x10 ml 100mm</p>  <p>Wirówka/Centrifuge: <b>MPW-380</b> R<sub>max</sub> = <b>9,4 cm</b> <b>14000 rpm, 20598 RCF</b></p>
<p><b>11769</b> <span style="float: right;">HU</span> 45° 60x2/1,5 ml</p>  <p>Wirówka/Centrifuge: <b>MPW-380</b> Wkładka/Adaptor: <b>14084, 14126, 14133</b> R<sub>max</sub> = <b>9,7 cm</b> <b>16400 rpm, 29168 RCF</b></p>	<p><b>11770</b> <span style="float: right;">HU</span> 30° 12x15 ml Falcon</p>  <p>Wirówka/Centrifuge: <b>MPW-380</b> R<sub>max</sub> = <b>10,6 cm</b> <b>14000 rpm, 23227 RCF</b></p>	<p><b>11772</b> <span style="float: right;">HU</span> 30° 8x30 ml Nalgene</p>  <p>Wirówka/Centrifuge: <b>MPW-380</b> R<sub>max</sub> = <b>8,7 cm</b> <b>17500 rpm, 29787 RCF</b></p>	<p><b>11773</b> <span style="float: right;">HU</span> 30° 6x50 ml Nalgene</p>  <p>Wirówka/Centrifuge: <b>MPW-380</b> Wkładka/Adaptor: <b>14036</b> R<sub>max</sub> = <b>9,2 cm</b> <b>14500 rpm, 21625 RCF</b></p>	<p><b>11775</b> <span style="float: right;">HU</span> 30° 8x50 ml Nalgene</p>  <p>Wirówka/Centrifuge: <b>MPW-380</b> Wkładka/Adaptor: <b>14035, 14036</b> R<sub>max</sub> = <b>9,7 cm</b> <b>14000 rpm, 21255 RCF</b></p>	<p><b>11776</b> <span style="float: right;">HU</span> 30° 8x50 ml Falcon</p>  <p>Wirówka/Centrifuge: <b>MPW-380</b> Wkładka/Adaptor: <b>14071, 14073, 14089</b> R<sub>max</sub> = <b>10,8 cm</b> <b>14000 rpm, 23666 RCF</b></p>
<p><b>11777</b> <span style="float: right;">HU</span> 25° 4x250 ml</p>  <p>Wirówka/Centrifuge: <b>MPW-380</b> Wkładka/Adaptor: <b>14017</b> R<sub>max</sub> = <b>12,6 cm</b> <b>10000 rpm, 14086 RCF</b></p>	<p><b>11778</b> <span style="float: right;">HU</span> 30° 6x94/85 ml Nalgene</p>  <p>Wirówka/Centrifuge: <b>MPW-380</b> Wkładka/Adaptor: <b>14855, 14856</b> R<sub>max</sub> = <b>11,0 cm</b> <b>12000 rpm, 17710 RCF</b></p>	<p><b>11779</b> <span style="float: right;">HU</span> 45° 36x2 ml filtr</p>  <p>Wirówka/Centrifuge: <b>MPW-380</b> Wkładka/Adaptor: <b>14084, 14126, 14133</b> R<sub>max</sub> = <b>8,8 cm</b> <b>15000 rpm, 22136 RCF</b></p>	<p><b>11780</b> 30° 12x50 ml Falcon</p>  <p>Wirówka/Centrifuge: <b>MPW-380</b> Pojemnik/Bucket: <b>13275, 13276</b> R<sub>max</sub> = <b>14,7 cm</b> <b>4500 rpm, 3328 RCF</b></p>	<p><b>11784</b> 30° 36x15 ml Falcon</p>  <p>Wirówka/Centrifuge: <b>MPW-380</b> Pojemnik/Bucket: <b>13080, 13081</b> R<sub>max</sub> = <b>14,3 cm</b> <b>5000 rpm, 3996 RCF</b></p>	<p><b>11785</b> kątowy/angle 30° 48x15 ml Falcon</p>  <p>Wirówka/Centrifuge: <b>MPW-380</b> Pojemnik/Bucket: <b>13080, 13081</b> R<sub>max</sub> = <b>16,3 cm</b> <b>4700 rpm, 4025 RCF</b></p>

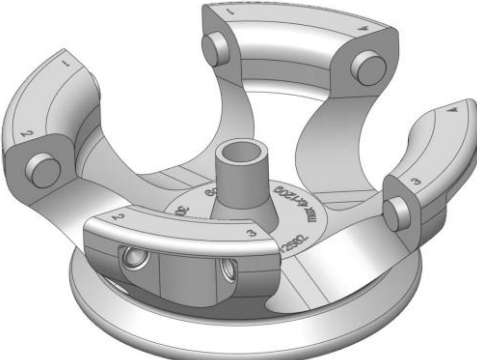
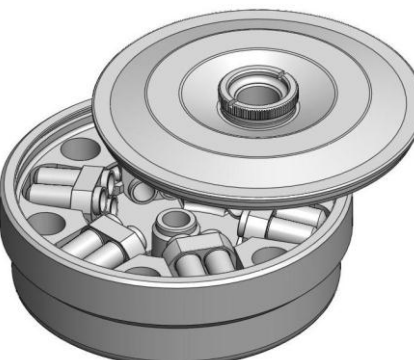
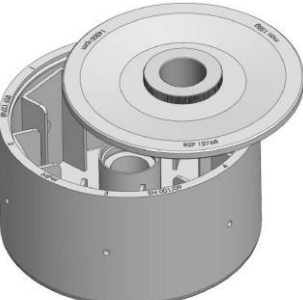
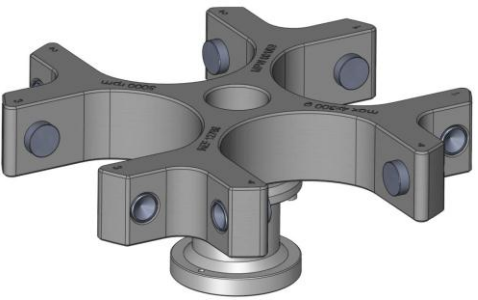
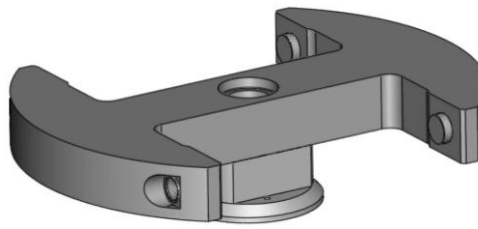
<p><b>12172</b> <b>HU</b> bębnowy/drum 6kaset 20x0,4/0,2 ml 10x2/1,5 ml</p>  <p>Wirówka/Centrifuge: <b>MPW-260, 351,352</b> Kasety/cassettes: <b>14000, 14002</b> R<sub>max</sub> = <b>7,0 cm</b> <b>14500 rpm, 16450 RCF</b></p>	<p><b>12177</b> 4x250 ml</p>  <p>Wirówka/Centrifuge: <b>MPW-351,352</b> Pojemnik/Bucket: <b>13174, 13178, 13180</b> R<sub>max</sub> = <b>16,9 cm</b> <b>5000 rpm, 4724 RCF</b></p>	<p><b>12183</b> 4x100 ml</p>  <p>Wirówka/Centrifuge: <b>MPW-223e, 251, 260</b> Pojemnik/Bucket: <b>13182, 13184, 13195, 13266, 13267/c</b> R<sub>max</sub> = <b>13,8 cm; 4000 rpm, 2469 RCF</b></p>	<p><b>12193</b> 8x15/10 ml</p>  <p>Wirówka/Centrifuge: <b>MPW-223e, 251, 260</b> Pojemnik/Bucket: <b>13080, 13081</b> R<sub>max</sub> = <b>14,0 cm</b> <b>4000 rpm, 2504 RCF</b></p>	<p><b>12205</b> hematokrytowy/hematorcit 24 kap./cap. 19 µl (1,3x50mm)</p>  <p>Wirówka/Centrifuge: <b>MPW-55</b> R<sub>max</sub> = <b>6,2 cm</b> <b>14500 rpm, 14574 RCF</b></p>	<p><b>12218</b> titracyjny/MTP</p>  <p>Wirówka/Centrifuge: <b>MPW-223c, 251, 260</b> Zawieszka/Hanger: <b>13219</b> R<sub>max</sub> = <b>9,1 cm; 3000 rpm, 916 RCF</b> <b>2500 rpm, 636 RCF</b></p>
<p><b>12232</b> 4x70 ml</p>  <p>Wirówka/Centrifuge: <b>MPW-223e, 251, 260</b> Pojemnik/Bucket: <b>13170, 13233</b> R<sub>max</sub> = <b>12,9 cm</b> <b>4000 rpm, 2308 RCF</b></p>	<p><b>12270</b> 12 kart żelowych/gel cards</p>  <p>Wirówka/Centrifuge: <b>MPW-223a</b> Pojemnik/Bucket: <b>12xPojemnik/Bucket do testów kolumnowych</b> R<sub>max</sub> = <b>7,6 cm</b> <b>1000 rpm, 85 RCF</b></p>	<p><b>12271</b> cytologiczny/CYTO</p>  <p>Wirówka/Centrifuge: <b>MPW-223c</b> Pojemnik/Bucket: <b>4x13606</b> R<sub>max</sub> = <b>11,0 cm</b> <b>2500 rpm, 750 RCF</b></p>	<p><b>12285</b> titracyjny/MTP</p>  <p>Wirówka/Centrifuge: <b>MPW-351e, 351,352</b> Zawieszka/Hanger: <b>2x13286</b> R<sub>max</sub> = <b>11,6 cm</b> <b>4300 rpm, 2397 RCF</b></p>	<p><b>12300</b> hematokrytowy/hematorcit 24 kapilary 37 µl</p>  <p>Wirówka/Centrifuge: <b>MPW-251, 260, 351,352</b> R<sub>max</sub> = <b>8,9 cm</b> <b>13000 rpm, 16816 RCF</b></p>	<p><b>12331</b> 4x10 ml</p>  <p>Wirówka/Centrifuge: <b>MPW-223b</b> Pojemnik/Bucket: <b>13081, 13083</b> R<sub>max</sub> = <b>13,0 cm</b> <b>4000 rpm, 2320 RCF</b></p>
<p><b>12436</b> 4x200 ml</p>  <p>Wirówka/Centrifuge: <b>MPW-351e,</b> Pojemnik/Bucket: <b>13042, 13045, 13437, 13438, 13593</b> Zawieszki: <b>13044, 13129</b> R<sub>max</sub> = <b>14,6 cm</b> <b>5200 rpm, 4413 RCF</b></p>	<p><b>12451</b> titracyjny/MTP</p>  <p>Wirówka/Centrifuge: <b>MPW-351,352</b> Zawieszka/Hanger: <b>2x13307</b> R<sub>max</sub> = <b>10,3 cm</b> <b>3000 rpm, 1036 RCF</b></p>	<p><b>12452</b> cytologiczny/CYTO 4 próbki CYTO/cyto samples</p>  <p>Wirówka/Centrifuge: <b>MPW-351,352</b> Zawieszka/Hanger: <b>4x13606</b> R<sub>max</sub> = <b>11,0 cm</b> <b>2500 rpm, 750 RCF</b></p>	<p><b>12464</b> <b>HU</b> 24x2/1,5 ml</p>  <p>Wirówka/Centrifuge: <b>MPW-351,352</b> Zawieszka/Hanger: <b>6x13483</b> R<sub>max</sub> = <b>7,3 cm</b> <b>14000 rpm, 15996 RCF</b></p>	<p><b>12480</b> hematokrytowy/hematorcit 24 kapilary 37 µl (1,4x75mm)</p>  <p>Wirówka/Centrifuge: <b>MPW-65R, 215</b> R<sub>max</sub> = <b>8,9 cm</b> <b>13000 rpm, 16816 RCF</b></p>	<p><b>12485</b> 4x50 ml</p>  <p>Wirówka/Centrifuge: <b>MPW-223e</b> Pojemnik/Bucket: <b>13245, 13246, 13247, 13249, 13250</b> R<sub>max</sub> = <b>13,8 cm</b> <b>4000 rpm, 2468 RCF</b></p>

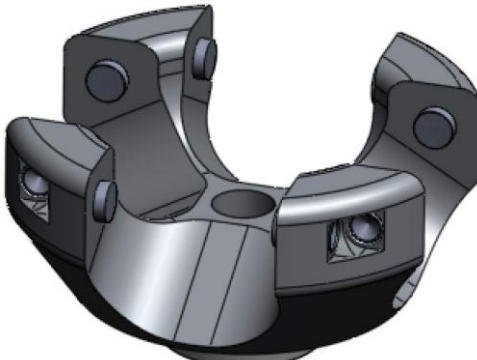
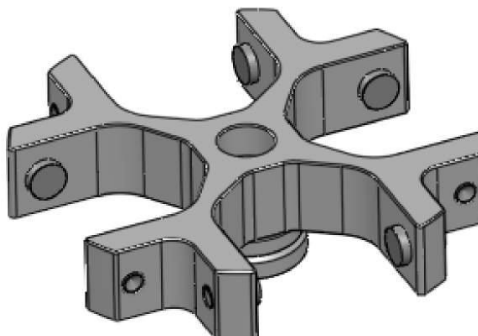
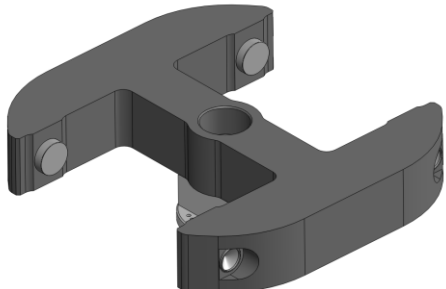
<p><b>12582</b> 4x40 ml CPT</p>  <p>Wirówka/Centrifuge: <b>MPW-351,352</b> Pojemnik/Bucket: <b>13583</b> R<sub>max</sub> = <b>15,8 cm</b> <b>3200 rpm, 1809 RCF</b></p>	<p><b>12730</b> <b>HU</b> 24x2/1,5 ml</p>  <p>Wirówka/Centrifuge: <b>MPW-65R</b> Zawieszka/Hanger: <b>6x13483</b> R<sub>max</sub> = <b>7,3 cm</b> <b>14000 rpm, 16000 RCF</b> <b>*do wycofania z 65R</b></p>	<p><b>12768</b> <b>HU</b> bębnowy/drum 6kaset 20x0,4/0,2 ml 10x2/1,5 ml</p>  <p>Wirówka/Centrifuge: <b>MPW-380</b> Kasety/cassettes: <b>14000, 14002</b> R<sub>max</sub> = <b>7,0 cm</b> <b>14500 rpm, 16454 RCF</b></p>	<p><b>12786</b> 4x250 ml</p>  <p>Wirówka/Centrifuge: <b>MPW-380</b> Pojemnik/Bucket: <b>13174, 13178, 13180, 13580</b> R<sub>max</sub> = <b>16,9 cm</b> <b>5000 rpm, 4724 RCF</b></p>	<p><b>12787</b> titracyjny/MTP</p>  <p>Wirówka/Centrifuge: <b>MPW-380</b> Zawieszka/Hanger: <b>2x13286</b> R<sub>max</sub> = <b>11,6 cm</b> <b>4300 rpm, 2398 RCF</b></p>	<p><b>12788</b> titracyjny/MTP</p>  <p>Wirówka/Centrifuge: <b>MPW-380</b> Zawieszka/Hanger: <b>4x13789</b> R<sub>max</sub> = <b>15,8 cm</b> <b>4000 rpm, 2826 RCF</b></p>
<p><b>12791</b> 4xASTM</p>  <p>Wirówka/Centrifuge: <b>MPW-380</b> Pojemnik/Bucket: <b>13792</b> R<sub>max</sub> = <b>18,5 cm</b> <b>2500 rpm, 1292 RCF</b></p>	<p><b>12830</b> 4x400 ml</p>  <p>Wirówka/Centrifuge: <b>MPW-380</b> Pojemnik/Bucket: <b>13831, 13833, 13865, 13866</b> R<sub>max</sub> = <b>18,5 cm</b> <b>4500 rpm, 4188 RCF</b></p>	<p><b>12926</b> 2x5 MTP (standard) 2x2 MTP (deepwell) Hmax=85mm</p>  <p>Wirówka/Centrifuge: <b>MPW-380</b> Pojemnik/Bucket: <b>13927</b> R<sub>max</sub> = <b>14,0 cm</b> <b>5700 rpm, 5058 RCF</b></p>			

**13042**

Pojemnik/Bucket 2x50 ml  
Falcon

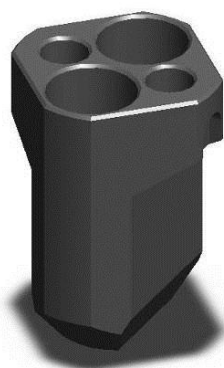

Wirówka/Centrifuge: **351e, 351,352**  
Wirnik/Rotor: **12436**  
Probówka/Tube: **15050, 15052**

φ30x120

**13044**

Zawieszka/Hanger 4x15 ml  
Falcon



Wirówka/Centrifuge: **351e, 351,352**  
Wirnik/Rotor: **12436**  
Pojemnik/Bucket: **13080**  
Wkładka/Adaptor: **14082**  
Probówka/Tube: **15048, 15050, 15053, 15054, 15118, 15119, 15120, 15121, 15419,**

**13044c**

Zawieszka/Hanger 4x15 ml  
Falcon

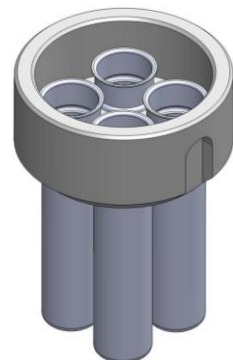

Wirówka/Centrifuge: **351e, 351,352**  
Wirnik/Rotor: **12436**  
Wkładka/Adaptor: **14082**  
Probówka/Tube: **15048, 15050, 15053, 15054, 15118, 15119, 15120, 15121, 15419,**

**13045**

Pojemnik/Bucket 50 ml  
Falcon



Wirówka/Centrifuge: **351e, 351,352**  
Wirnik/Rotor: **12436**  
Probówka/Tube: **15051**

φ30x120

**13080**

Pojemnik/Bucket 15 ml



Wirówka/Centrifuge: **54, 56, 223e, 251, 260, 351e, 351,352, 380**  
Wirnik/Rotor: **11101, 11107, 11140, 11141, 11145, 11210, 11217, 11237, 11253, 11453, 11454, 11456, 11465, 11486, 11487, 11501, 11502, 11740, 11741, 11745, 11784, 11785, 12193, 12436**  
Zawieszka/Hanger: **13044, 13129, 13195(13080a), 13246, 13247**  
Wkładka/Adaptor: **14082**  
Probówka/Tube: **15048, 15050, 15053, 15054, 15118, 15119**

φ17x100/120

**13081**

Pojemnik/Bucket 10/6 ml



Wirówka/Centrifuge: **54, 56, 223b, 223e, 251, 260, 351e, 351,352, 380**  
Wirnik/Rotor: **11101, 11107, 11140, 11141, 11145, 11210, 11217, 11237, 11253, 11453, 11454, 11456, 11465, 11486, 11487, 11501, 11502, 11740, 11741, 11745, 11784, 11785, 12193, 12331**  
Wkładka/Adaptor: **14082**  
Probówka/Tube: **15048, 15050, 15053, 15054, 15118, 15119, 15120, 15121, 15419,**

φ17x70/85

**13083**

Pojemnik/Bucket 10 ml  
Monovette



Wirówka/Centrifuge: **223b**  
Wirnik/Rotor: **12331**  
Wkładka/Adaptor: **14083**  
Probówka/Tube: **15048, 15050, 15053, 15054, 15118, 15119, 15120, 15121, 15419,**

φ17x92

**13129**

Zawieszka/Hanger 2x15 ml  
Falcon

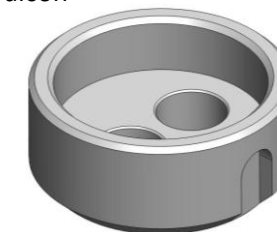

Wirówka/Centrifuge: **351e, 351,352**  
Wirnik/Rotor: **12436**  
Pojemnik/Bucket: **13080**  
Wkładka/Adaptor: **14082**  
Probówka/Tube: **15048, 15050, 15053, 15054, 15118, 15119, 15120, 15121, 15419,**

**13129c**

Zawieszka/Hanger 2x15 ml  
Falcon

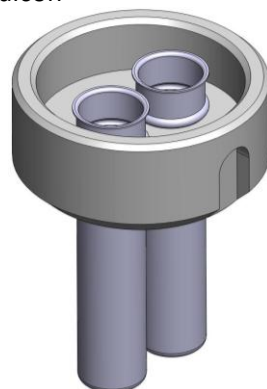

Wirówka/Centrifuge: **351e, 351,352**  
Wirnik/Rotor: **12436**  
Wkładka/Adaptor: **14082**  
Probówka/Tube: **15048, 15050, 15053, 15054, 15118, 15119, 15120, 15121, 15419,**

**13170**

Pojemnik/Bucket 12x5 ml  
Monovette

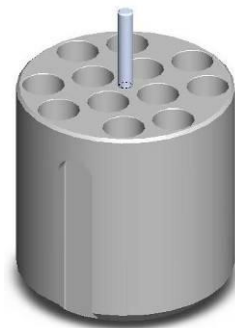

Wirówka/Centrifuge: **223e, 251, 260**  
Wirnik/Rotor: **12232**  
Probówka/Tube: **15120, 15419,**

φ13x81

**13174**

Pojemnik/Bucket 250 ml



Wirówka/Centrifuge: **351,352, 380**  
Wirnik/Rotor: **12177, 12786**  
Wkładka/Adaptor: **14017, 14175, 14151-14160**  
Probówka/Tube: **15015, 15017, 15040, 15046, 15048, 15050, 15052, 15053, 15054, 15115, 15119, 15120, 15175, 15176, 15419,**

φ62x107

**13178**

Pojemnik/Bucket 250 ml  
z gwintem/with thread



Wirówka/Centrifuge: **351,352, 380**  
Wirnik/Rotor: **12177, 12786**  
Pokrywka/Lid: **17179**  
Wkładka/Adaptor: **14017, 14175, 14151-14160**  
Probówka/Tube: **15015, 15017, 15040, 15046, 15048, 15050, 15052, 15053, 15054, 15115, 15119, 15120, 15175, 15176, 15419,**

φ62x107

**13178c**

Pojemnik/Bucket 250 ml  
z pokrywką/with lid



φ62x107

Wirówka/Centrifuge: **351,352, 380**  
Wirnik/Rotor: **12177, 12786**  
Pokrywka/Lid: **17179**  
Wkładka/Adaptor: **14017, 14175, 14151-14160**  
Probówka/Tube: **15015, 15017, 15040, 15046, 15048, 15050, 15052, 15053, 15054, 15115, 15119, 15120, 15175, 15176, 15419,**

**13180**

Pojemnik/Bucket 2x50 ml  
Falcon

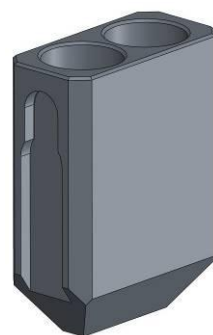

φ30x120

Wirówka/Centrifuge: **351,352, 380**  
Wirnik/Rotor: **12177, 12786**  
Wkładka/Adaptor: **14089**  
Probówka/Tube: **15050, 15052**

**13182**

Pojemnik/Bucket 100 ml



φ45x89

Wirówka/Centrifuge: **223e, 251, 260**  
Wirnik/Rotor: **12183**  
Wkładka/Adaptor: **14024, 14181, 14186, 14187, 14188, 14189c, 14190c, 14192c, 14196**  
Probówka/Tube: **15040, 15052, 15054, 15055, 15115, 15116, 15117, 15118, 15119, 15120, 15419, 15048**

**13184**

Pojemnik/Bucket 100 ml z  
gwintem/with thread



φ45x96

Wirówka/Centrifuge: **223e, 251, 260**  
Wirnik/Rotor: **12183**  
Wkładka/Adaptor: **14024, 14181, 14186, 14187, 14188, 14189c, 14190c, 14192c, 14196**  
Probówka/Tube: **15040, 15051, 15052, 15054, 15055, 15115, 15116, 15117, 15118, 15119, 15120, 15419, 15048**

**13184c**

Pojemnik/Bucket 100 ml z  
pokrywką/with lid



φ45x96

Wirówka/Centrifuge: **223e, 251, 260**  
Wirnik/Rotor: **12183**  
Pokrywka/Lid: **17185**  
Wkładka/Adaptor: **14024, 14181, 14186, 14187, 14188, 14189, 14189c, 14190c, 14192c, 14196**  
Probówka/Tube: **15040, 15051, 15052, 15054, 15055, 15115, 15116, 15117, 15118, 15119, 15120, 15419, 15 051**

**13195c**

Zawieszka/Hanger 2x15 ml  
Falcon

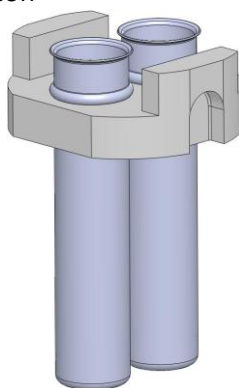

Wirówka/Centrifuge: **223e, 251, 260**  
Wirnik/Rotor: **12183**  
Wkładka/Adaptor: **14082**  
Probówka/Tube: **15048, 15050, 15053, 15054, 15118, 15119,**

**13219**

Zawieszka/Hanger na 1  
płytkę titracyjną



85x130

Wirówka/Centrifuge: **223c, 251, 260**  
Wirnik/Rotor: **12218**  
Probówka/Tube: **15102**

**13233**

Pojemnik/Bucket 70 ml

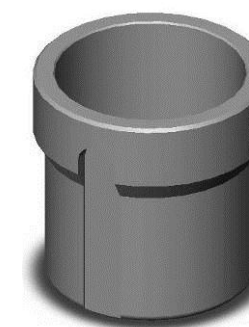

φ57x66

Wirówka/Centrifuge: **223e, 251, 260**  
Wirnik/Rotor: **12232**  
Wkładka/Adaptor: **14169, 14235, 14238, 14239, 14240, 14242**  
Probówka/Tube: **15011, 15015, 15016, 15120, 15128, 15419,**

**13245**

Pojemnik/Bucket 5x5 ml

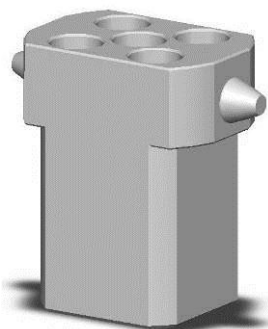

φ13,1x62

Wirówka/Centrifuge: **223e**  
Wirnik/Rotor: **12485**

**13246c**

Pojemnik/Bucket 4x10 ml

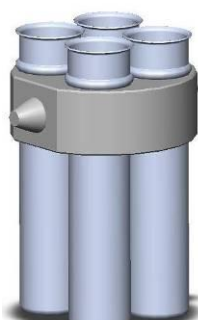

φ17x87

Wirówka/Centrifuge: **223e**  
Wirnik/Rotor: **12485**  
Wkładka/Adaptor: **14082**  
Probówka/Tube: **15048, 15053, 15054, 15118, 15119**

**13247c**

Zawieszka/Hanger 2x15 ml

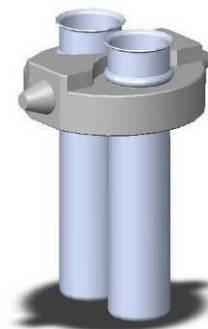

φ17x87

Wirówka/Centrifuge: **223e**  
Wirnik/Rotor: **12485**  
Wkładka/Adaptor: **14082**  
Probówka/Tube: **15048, 15050, 15053, 15054, 15118, 15119**

**13249**

Pojemnik/Bucket 50 ml z  
gwintem/with thread  
Falcon

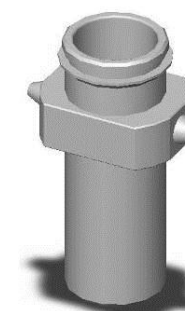

φ30x99

Wirówka/Centrifuge: **223e**  
Wirnik/Rotor: **12485**  
Wkładka/Adaptor: **14248**  
Probówka/Tube: **15052, 15055, 15117**

**13249c**

Pojemnik/Bucket 50 ml  
Falcon  
z pokrywą



φ30x99

Wirówka/Centrifuge: **223e**  
Wirnik/Rotor: **12485**  
Pokrywka/Lid: **17151**  
Wkładka/Adaptor: **14248**  
Probówka/Tube: **15052, 15055, 15117**

**13250**

Pojemnik/Bucket 50 ml  
Falcon

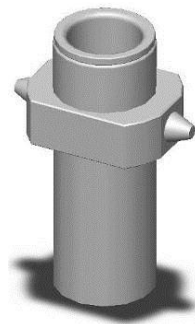

φ30x96

Wirówka/Centrifuge: **223e**  
Wirnik/Rotor: **12485**  
Wkładka/Adaptor: **14248, 14089**  
Probówka/Tube: **15050, 15052, 15055, 15117**

**13265**

Pojemnik/Bucket do  
systemu Arthrex ACP

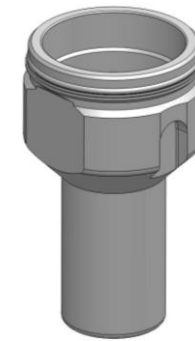

φ27/45x120

Wirówka/Centrifuge: **223e, 251, 260**  
Wirnik/Rotor: **12183**  
Probówka/Tube: **System Arthrex ACP**

**13265c**

Pojemnik/Bucket do  
systemu Arthrex ACP z  
pokrywką/with lid

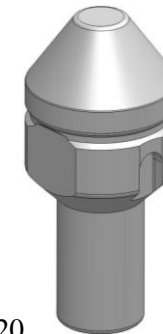

φ27/45x120

Wirówka/Centrifuge: **223e, 251, 260**  
Wirnik/Rotor: **12183**  
Pokrywka/Lid: **17265**  
Probówka/Tube: **System Arthrex ACP**

**13266**

Pojemnik/Bucket 50 ml  
Falcon



φ30x100

Wirówka/Centrifuge: **223e, 251, 260**  
Wirnik/Rotor: **12183**  
Wkładka/Adaptor: **14089, 14248**  
Probówka/Tube: **15050, 15052, 15055, 15117**

**13267**

Pojemnik/Bucket 50 ml z  
gwintem/with thread  
Falcon



φ30x100

Wirówka/Centrifuge: **223e, 251, 260**  
Wirnik/Rotor: **12183**  
Wkładka/Adaptor: **14248**  
Probówka/Tube: **15052, 15055, 15117**

**13267c**

Pojemnik/Bucket 50 ml z  
pokrywką/with lid Falcon



φ30x100

Wirówka/Centrifuge: **223e, 251, 260**  
Wirnik/Rotor: **12183**  
Pokrywka/Lid: **17151**  
Wkładka/Adaptor: **14248**  
Probówka/Tube: **15052, 15055, 15117**

**13275**

Pojemnik/Bucket 50 ml  
Falcon z gwintem/with  
thread



φ30x99

Wirówka/Centrifuge: **251, 260, 351e, 351,352, 380**  
Wirnik/Rotor: **11211, 11213, 11254, 11780**  
Wkładka/Adaptor: **14248**  
Probówka/Tube: **15052, 15055, 15117**

**13275c**

Pojemnik/Bucket 50 ml  
Falcon z pokrywką/with lid



φ30x99

Wirówka/Centrifuge: **251, 260, 351e, 351,352, 380**  
Wirnik/Rotor: **11211, 11213, 11254, 11780**  
Pokrywka/Lid: **17151**  
Wkładka/Adaptor: **14248**  
Probówka/Tube: **15052, 15055, 15117**

**13276**

Pojemnik/Bucket 50 ml  
Falcon



φ30x96

Wirówka/Centrifuge: **223e, 251, 260, 351e, 351,352, 380**  
Wirnik/Rotor: **11211, 11213, 11254, 11333, 11744, 11746, 11780**  
Wkładka/Adaptor: **14035, 14036, 14043, 14071, 14089, 14248**  
Probówka/Tube: **15050, 15052, 15055, 15117**

**13286**

Pojemnik/Bucket na 3-5  
MTP(standard / MTP  
(deepwell))

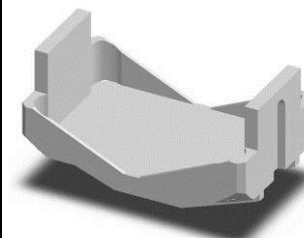

85x130x60

Wirówka/Centrifuge: **351e, 351,352, 380**  
Wirnik/Rotor: **12285, 12787**  
Probówka/Tube: **15102**

**13307**

Pojemnik/Bucket na 1-3  
MTP(standard / MTP  
(deepwell))

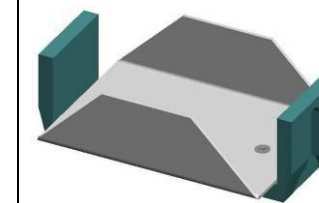

85x130x60

Wirówka/Centrifuge: **351,352**  
Wirnik/Rotor: **12451**  
Probówka/Tube: **15102**

**13329**

Pojemnik/Bucket 30 ml



φ25,5x100

Wirówka/Centrifuge: **223e, 251, 260, 351e, 351,352**  
 Wirnik/Rotor: **11257, 11329, 11332, 11742, 11743**  
 Wkładka/Adaptor: **14255, 14256**  
 Probówka/Tube: **15046, 15048, 15053, 15054, 15118, 15119**

**13437**

Pojemnik/Bucket 200 ml

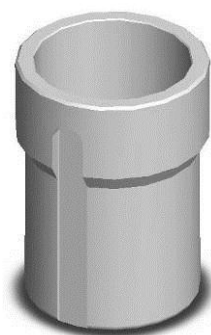

φ57x100

Wirówka/Centrifuge: **351e, 351,352**  
 Wirnik/Rotor: **12436**  
 Wkładka/Adaptor: **14104, 14106, 14108, 14109, 14110, 14111, 14112, 14113, 14441, 14443, 14444, 14446, 14447a, 14449, 14450**  
 Probówka/Tube: **15011, 15015, 15016, 15046, 15048, 15052, 15053, 15054, 15055, 15056, 15115, 15117, 15118, 15119, 15120, 15128, 15419, 15424**

**13438**

Pojemnik/Bucket 200 ml z gwintem/with thread



φ57x100

Wirówka/Centrifuge: **351e, 351,352**  
 Wirnik/Rotor: **12436**  
 Wkładka/Adaptor: **14104, 14106, 14108, 14109, 14110, 14111, 14112, 14113, 14441, 14443, 14444, 14446, 14447a, 14449, 14450**  
 Probówka/Tube: **15011, 15015, 15016, 15046, 15048, 15052, 15053, 15054, 15055, 15056, 15115, 15117, 15118, 15119, 15120, 15128, 15419, 15424**

**13438c**

Pojemnik/Bucket 200 ml z pokrywką/with lid

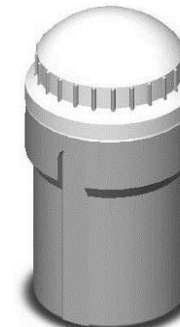

φ57x100

Wirówka/Centrifuge: **351e, 351,352**  
 Wirnik/Rotor: **12436**  
 Pokrywka/Lid: **17111**  
 Wkładka/Adaptor: **14104, 14106, 14108, 14109, 14110, 14111, 14112, 14113, 14441, 14443, 14444, 14446, 14447a, 14449, 14450**  
 Probówka/Tube: **15011, 15015, 15016, 15046, 15048, 15052, 15053, 15054, 15055, 15056, 15115, 15117, 15118, 15119, 15120, 15128, 15419, 15424**

**13483**

Pojemnik/Bucket 4x2/1,5 ml

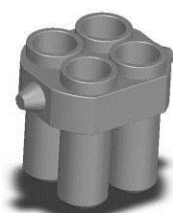

Wirówka/Centrifuge: **65R, 351,352**  
 Wirnik/Rotor: **12464, 12730**  
 Probówka/Tube: **15011, 15015, 15128**

**13504**

Pojemnik/Bucket butelki/bottles Babcock (Gerber 5406)

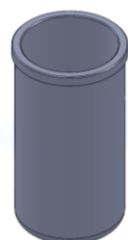

φ45x95

Wirówka/Centrifuge: **351**  
 Wirnik/Rotor: **11503**  
 Wkładka/Adaptor: **14505**  
 Probówka/Tube: butelka/bottle **Babcock (Gerber 5406)**

**13580**

Pojemnik/Bucket 2x50 ml na probówki/for tubes szklane

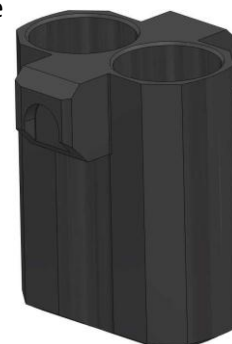

φ35x100

Wirówka/Centrifuge: **380**  
 Wirnik/Rotor: **12786**  
 Probówka/Tube: **15116**

**13583**

Pojemnik/Bucket CPT 130 mm

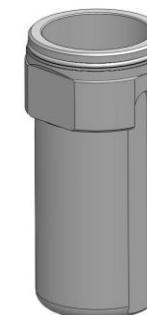

φ45x116

Wirówka/Centrifuge: **351,352**  
 Wirnik/Rotor: **12582**  
 Wkładka/Adaptor: **14584**

**13583c**

Pojemnik/Bucket CPT 130 mm z pokrywką/with lid

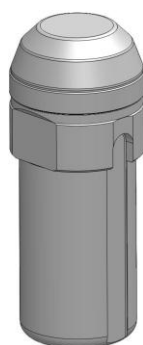

φ45x116

Wirówka/Centrifuge: **351,352**  
 Wirnik/Rotor: **12582**  
 Pokrywka/Lid: **17185**  
 Wkładka/Adaptor: **14584**

**13587**

Pojemnik/Bucket 85 ml Nalgene



φ38,5x90,5

Wirówka/Centrifuge: **351,352**  
 Wirnik/Rotor: **11586**  
 Wkładka/Adaptor: **14855, 14856**  
 Probówka/Tube: **15050, 15052, 15067**



**13593**

Pojemnik/Bucket 100 ml



φ45x94

Wirówka/Centrifuge: **351e, 351,352**Wirnik/Rotor: **12436**  
Wkładka/Adaptor: **14181, 14186, 14187, 14188, 14189c, 14190c, 14192c, 14196**Probówka/Tube: **15040, 15052, 15054, 15055, 15115, 15116, 15117, 15118, 15119, 15120, 15419,****13606**

Zawieszka/Hanger CYTO

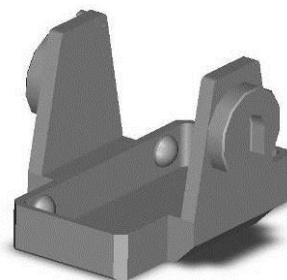
Wirówka/Centrifuge: **223c, 351,352**Wirnik/Rotor: **12271, 12452**Wkładka/Adaptor: **16610**Probówka/Tube: **15123****13719**

Pojemnik/Bucket 100 ml

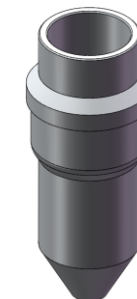

φ45x96

Wirówka/Centrifuge: **251, 260, 351,352**Wirnik/Rotor: **11718**Wkładka/Adaptor: **14024, 14188, 14189c, 14190c, 14192c, 14196**Probówka/Tube: **15040, 15050, 15052, 15055, 15115, 15116, 15117, 15118****13721**Pojemnik/Bucket 60 ml  
Orthokin II

φ32,5x145

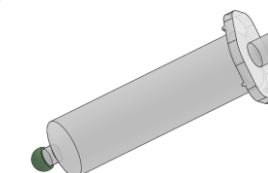
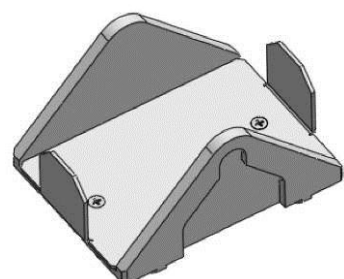
Wirówka/Centrifuge: **223es**  
Wirnik/Rotor: **11720**  
Probówka/Tube: **Orthokin II 60ml****13789**Pojemnik/Bucket na 1-4  
MTP(standard / MTP  
(deepwell))

85x130x60

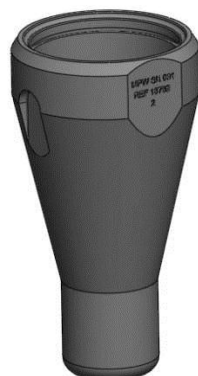
Wirówka/Centrifuge: **380**  
Wirnik/Rotor: **12788**  
Probówka/Tube: **15102****13792**Pojemnik/Bucket na  
naczynia ASTM

φ32/62x142

Wirówka/Centrifuge: **380**Wirnik/Rotor: **12791**Wkładka/Adaptor: **14794, 14795**Probówka/Tube: **15796, 15797****13792c**Pojemnik/Bucket na  
naczynia ASTM z  
pokrywką/with lid

φ32/62x142

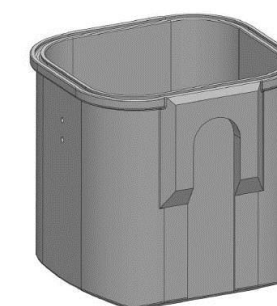
Wirówka/Centrifuge: **380**Wirnik/Rotor: **12791**Pokrywka/Lid: **17792**  
Wkładka/Adaptor: **14794, 14795**Probówka/Tube: **15796, 15797****13831**Pojemnik/Bucket  
prostokątny/rectangular

84x96x101

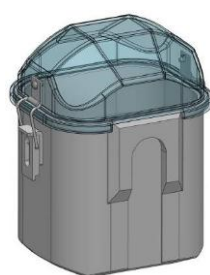
Wirówka/Centrifuge: **380**  
Wirnik/Rotor: **12830**  
Wkładka/Adaptor: **14175, 14793, 14836, 14837, 14838, 14839, 14840, 14841, 14842, 14844, 14860, 14862**  
Probówka/Tube: **15011, 15015, 15016, 15040, 15046, 15048, 15050, 15052, 15053, 15054, 15055, 15056, 15115, 15117, 15118, 15119, 15120, 15128, 15175, 15176, 14176, 15419, 15424,****13831c**Pojemnik/Bucket  
prostokątny/rectangular z  
pokrywką/with lid

84x96x101

Wirówka/Centrifuge: **380**  
Wirnik/Rotor: **12830**  
Pokrywka/Lid: **17832**  
Wkładka/Adaptor: **14175, 14793, 14836, 14837, 14838, 14839, 14840, 14841, 14842, 14844, 14860, 14862**  
Probówka/Tube: **15011, 15015, 15016, 15040, 15046, 15048, 15050, 15052, 15053, 15054, 15055, 15056, 15115, 15117, 15118, 15119, 15120, 15128, 15175, 15176, 15419, 15424,****13833**Pojemnik/Bucket  
okrągły/round  
400 ml

φ85x103,5

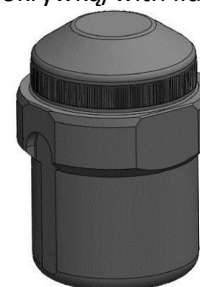
Wirówka/Centrifuge: **380**  
Wirnik/Rotor: **12830**  
Wkładka/Adaptor: **14175, 14845, 14846, 14847, 14848, 14849, 14850, 14851, 14853, 14854, 14859, 14861**  
Probówka/Tube: **15011, 15015, 15016, 15040, 15046, 15048, 15050, 15052, 15053, 15054, 15055, 15056, 15115, 15116, 15117, 15118, 15119, 15120, 15128, 15175, 15176, 15419, 15424, 15440****13833c**Pojemnik/Bucket  
okrągły/round  
400 ml z pokrywką/with lid

φ85x103,5

Wirówka/Centrifuge: **380**  
Wirnik/Rotor: **12830**  
Pokrywka/Lid: **17834**  
Wkładka/Adaptor: **14175, 14845, 14846, 14847, 14848, 14849, 14850, 14851, 14853, 14854, 14859, 14861**  
Probówka/Tube: **15011, 15015, 15016, 15040, 15046, 15048, 15050, 15052, 15053, 15054, 15055, 15056, 15115, 15116, 15117, 15118, 15119, 15120, 15128, 15175, 14176, 15419, 15424, 15440**

## 13865

Pojemnik/Bucket **7x50 ml**  
Falcon

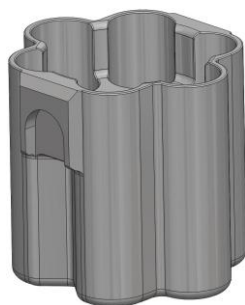

Wirówka/Centrifuge: **380**  
Wirnik/Rotor: **12830**  
Probówka/Tube: **15052**

## 13866

Pojemnik/Bucket **6x50 ml**  
Falcon

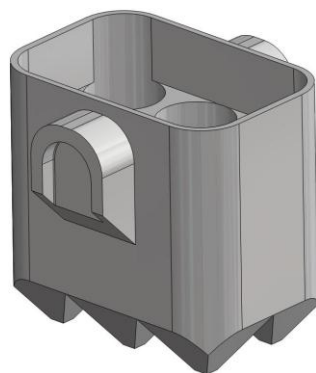

Wirówka/Centrifuge: **380**  
Wirnik/Rotor: **12830**  
Probówka/Tube: **15052**

## 13080a

Pojemnik/Bucket



Wirówka/Centrifuge: **54, 56, 223e, 251, 260, 351e, 351,352, 380**  
Wirnik/Rotor: **11101, 11107, 11140, 11141, 11145, 11210, 11217, 11237, 11253, 11453, 11454, 11456, 11465, 11486, 11487, 11740, 11741, 11745, 11784, 11785, 12193, 12436**  
Zawieszka/Hanger: **13044, 13129, 13195(13080a), 13246, 13247**  
Wkładka/Adaptor: **14082**  
Probówka/Tube: **15048, 15050, 15053, 15054, 15118, 15119**

## 13927c

Pojemnik/Bucket  
**5 MTP (standard)**  
**2 MTP (deepwell)**  
Hmax=85mm

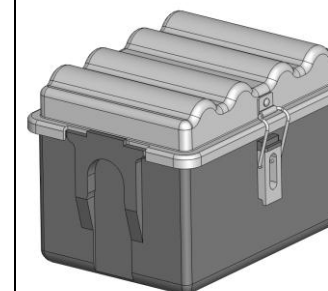

Wirówka/Centrifuge: **MPW-380**  
Wirnik/Rotor: **12926**  
Probówka/Tube: **15102**

**14000**

Wkładka/Adaptor na  
probówki/for tubes  
**20x0,4/0,2 ml**

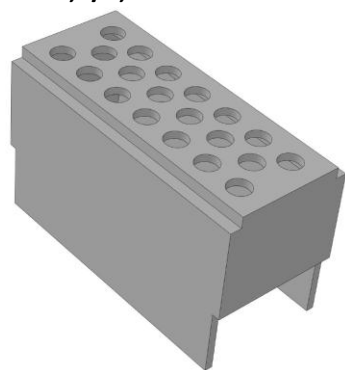

Wirówka/Centrifuge: **260, 351,352, 380**  
Wirnik/Rotor: **12172, 12768**  
Probówka/Tube: **15125**

**14002**

Wkładka/Adaptor na  
probówki/for tubes  
**10x1,5/2 ml**

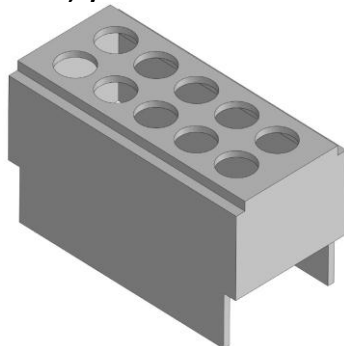

Wirówka/Centrifuge: **260, 351,352, 380**  
Wirnik/Rotor: **12172, 12768**  
Probówka/Tube: **15011, 15015, 15128**

**14017**

podkładka pod  
butelki/insert for bottles  
**250 ml okrągłodenne**

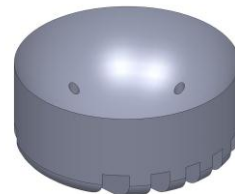

φ62

Wirówka/Centrifuge: **351,352, 380**  
Wirnik/Rotor: **12177, 12786, 11777**  
Pojemnik/Bucket: **13174, 13178**  
Probówka/Tube: **15017**

**14024**

Wkładka/Adaptor na  
probówki/for tubes  
**15 ml Falcon**

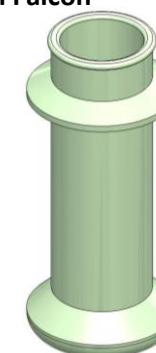

φ44,5/17x120

Wirówka/Centrifuge: **223e,251,260**  
Wirnik/Rotor: **12183**  
Pojemnik/Bucket: **13182, 13184, 13719**  
Probówka/Tube: **15050**

**14035**

Wkładka/Adaptor na  
probówki/for tubes  
**14 ml**



Wirówka/Centrifuge: **351,352**  
Wirnik/Rotor: **11469, 11775, 11211, 11213**  
Pojemnik/Bucket: **13276**  
Probówka/Tube: **15046**

φ28,5/17x105

**14036**

Wkładka/Adaptor na  
probówki/for tubes  
**5 ml**



Wirówka/Centrifuge: **351,352, 380**  
Wirnik/Rotor: **11469, 11773, 11775, 11211, 11213**  
Pojemnik/Bucket: **13276**  
Probówka/Tube: **specjalna (φ13,5x92mm)**

φ28,5/14x92

**14043**

Wkładka/Adaptor na  
probówki/for tubes  
**5 ml**

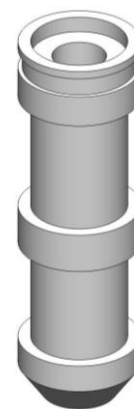

φ29/13x85

Wirówka/Centrifuge: **351,352, 380**  
Wirnik/Rotor: **11457, 11776, 11211, 11213**  
Pojemnik/Bucket: **13276**  
Probówka/Tube: **15419**

**14047**

Wkładka/Adaptor na  
probówki/for tubes  
**5 ml**



φ16,8/13x85

Wirówka/Centrifuge: **351,352, 380**  
Wirnik/Rotor: **11466, 11770**  
Probówka/Tube: **15419**

**14071**

Wkładka/Adaptor na  
probówki/for tubes  
**30 ml**



Wirówka/Centrifuge: **351,352, 380**  
Wirnik/Rotor: **11457, 11776, 11211, 11213**  
Pojemnik/Bucket: **13276**  
Probówka/Tube: **15055, 15117**

φ30/25x102

**14072**

Wkładka/Adaptor na  
probówki/for tubes  
**50 ml**

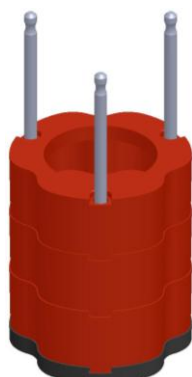

φ56,5/35x100

Wirówka/Centrifuge: **351e, 351,352**  
Wirnik/Rotor: **12436**  
Pojemnik/Bucket: **13437, 13438**  
Probówka/Tube: **15116**

**14073**

Wkładka/Adaptor na  
probówki/for tubes  
**10 ml**

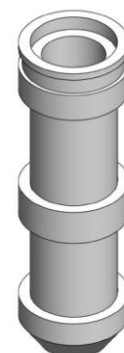

φ29/17x100

Wirówka/Centrifuge: **351,352, 380**  
Wirnik/Rotor: **11457,11776**  
Probówka/Tube: **15053, 15118**



**14082**

Wkładka/Adaptor na  
probówki/for tubes  
**7/5 ml**



φ17,6/13,3

Wirówka/Centrifuge: **54, 56, 223e, 251, 260, 351e, 351,352, 380**  
Pojemnik/Bucket: **13080, 13080a, 13081**  
Probówka/Tube: **15054, 15119, 15419, 15120**

<p><b>14083</b> Wkładka/Adaptor na probówki/for tubes 4,9 ml</p>  <p>φ17,6/13,3</p>	<p><b>14084</b> Wkładka/Adaptor na probówki/for tubes 0,5 ml</p>  <p>φ11/8</p>	<p><b>14089</b> Wkładka/Adaptor na probówki/for tubes 15 ml Falcon</p>  <p>φ29/17x120</p>	<p><b>14104</b> Wkładka/Adaptor na probówki/for tubes 100 ml</p>  <p>φ56,5/45,5x100</p>
<p><b>14106</b> Wkładka/Adaptor na probówki/for tubes 7x7 ml</p>  <p>φ56,5/13,5x100</p>	<p><b>14108</b> Wkładka/Adaptor na probówki/for tubes 7x10 ml niska(short)</p>  <p>φ56,5/17,1x75</p>	<p><b>14109</b> Wkładka/Adaptor na probówki/for tubes 7x5 ml niska(short)</p>  <p>φ56,5/13,5x75</p>	<p><b>14110</b> Wkładka/Adaptor na probówki/for tubes 7x15/10 ml</p>  <p>φ56,5/17,1x100</p>
<p><b>14111</b> Wkładka/Adaptor na probówki/for tubes 5x15 ml</p>  <p>φ56,5/16x100</p>	<p><b>14112</b> Wkładka/Adaptor na probówki/for tubes 3x30/</p>  <p>φ56,5/25,5x102</p>	<p><b>14113</b> Wkładka/Adaptor na probówki/for tubes 50 ml Falcon</p>  <p>φ56,5/30x120</p>	<p><b>14126</b> Wkładka/Adaptor na probówki/for tubes 0,4 ml</p>  <p>φ11/5,8x46</p>

Wirówka/Centrifuge: **223b**  
Pojemnik/Bucket: **13083**

Wirówka/Centrifuge: **55, 56, 65R, 215, 251, 260, 351,352, 380**  
Wirnik/Rotor: **11198, 11199, 11202, 11202a, 11204, 11204a, 11259, 11461, 11462, 11717, 11731, 11732, 11735, 11738, 11739, 11761, 11762, 11763, 11769, 11779**  
Probówka/Tube: **15127**

Wirówka/Centrifuge: **223e, 251, 260, 351e, 351,352, 380**  
Wirnik/Rotor: **11457, 11776, 11780**  
Pojemnik/Bucket: **13042\*, 13180\*, 13250, 13266, 13267, 13276, 13593\*, 13719\***  
Probówka/Tube: **15050**

\*-istnieje możliwość w razie potrzeby

Wirówka/Centrifuge: **351e, 351,352**  
Wirnik/Rotor: **12436**  
Pojemnik/Bucket: **13437, 13438**  
Probówka/Tube: **15115**

Wirówka/Centrifuge: **351e, 351,352**  
Wirnik/Rotor: **12436**  
Pojemnik/Bucket: **13437, 13438**  
Probówka/Tube: **15054, 15119**

Wirówka/Centrifuge: **351e, 351,352**  
Wirnik/Rotor: **12436**  
Pojemnik/Bucket: **13437, 13438**

Wirówka/Centrifuge: **351e, 351,352**  
Wirnik/Rotor: **12436**  
Pojemnik/Bucket: **13437, 13438**  
Probówka/Tube: **15120, 15419**

Wirówka/Centrifuge: **351e, 351,352**  
Wirnik/Rotor: **12436**  
Pojemnik/Bucket: **13437, 13438**  
Probówka/Tube: **15046\*, 15048\*, 15118**

Wirówka/Centrifuge: **351e, 351,352**  
Wirnik/Rotor: **12436**  
Pojemnik/Bucket: **13437, 13438**  
Probówka/Tube: **15048\*, 15053, 15118**

\*-warunkowo tylko do 13437 i 13438 bez pokrywki

Wirówka/Centrifuge: **351e, 351,352**  
Wirnik/Rotor: **12436**  
Pojemnik/Bucket: **13437, 13438**  
Probówka/Tube: **15055, 15117**

Wirówka/Centrifuge: **351e, 351,352**  
Wirnik/Rotor: **12436**  
Pojemnik/Bucket: **13437, 13438**  
Probówka/Tube: **15052**

Wirówka/Centrifuge: **65R, 215, 251, 260, 351,352, 380**  
Wirnik/Rotor: **11198, 11199, 11259, 11461, 11462, 11717, 11731, 11732, 11735, 11738, 11739, 11762, 11763, 11769, 11779**  
Probówka/Tube: **15124**

**14133**

Wkładka/Adaptor na probówki/for tubes  
0,2 ml



φ10,8/6,2x21

Wirówka/Centrifuge: **55, 56, 65R, 215, 251, 260, 351,352, 380**

Wirnik/Rotor: **11198, 11199, 11202, 11202a, 11204, 11204a, 11259, 11461, 11462, 11717, 11731, 11732, 11735, 11738, 11739, 11762, 11763, 11769, 11779**

Probówka/Tube: **15125**

**14134**

Wkładka/Adaptor na probówki/for tubes  
0,2 ml



φ7,8/6,2x21

Wirówka/Centrifuge: **55, 56, 65R, 215, 351,352**

Wirnik/Rotor: **11203, 11203a, 11460, 11733**

Probówka/Tube: **15125**

**14149**

Wkładka/Adaptor na probówki/for tubes  
4 ml płaskodenna/flat-bottom



φ16,8/14

Wirówka/Centrifuge: **351,352**

Wirnik/Rotor: **11459**

**14151**

Wkładka/Adaptor na probówki/for tubes  
100 ml



φ61/46x100

Wirówka/Centrifuge: **351,352, 380**

Wirnik/Rotor: **12177, 12786**

Pojemnik/Bucket: **13174, 13178**

Probówka/Tube: **15115**

**14152**

Wkładka/Adaptor na probówki/for tubes  
50 ml



φ61/30x120

Wirówka/Centrifuge:

**351,352, 380**

Wirnik/Rotor: **12177, 12786**

Pojemnik/Bucket: **13174, 13178**

Probówka/Tube: **15052**

**14153**

Wkładka/Adaptor na probówki/for tubes  
5x15 ml Falcon



φ61/17x120

Wirówka/Centrifuge:

**351,352, 380**

Wirnik/Rotor: **12177, 12786**

Pojemnik/Bucket: **13174, 13178**

Probówka/Tube: **15050**

**14154**

Wkładka/Adaptor na probówki/for tubes  
9x5 ml  
(hermetyczny/hermetic)

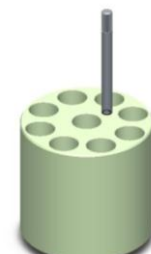

φ61/13,5x85

Wirówka/Centrifuge:

**351,352, 380**

Wirnik/Rotor: **12177, 12786**

Pojemnik/Bucket: **13174, 13178**

Probówka/Tube: **Vacurette**

**14155**

Wkładka/Adaptor na probówki/for tubes **12x7/5 ml**  
(typ otwarty)

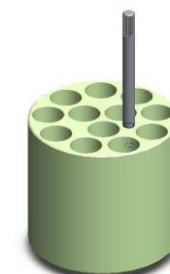

φ61/13x100

Wirówka/Centrifuge:

**351,352, 380**

Wirnik/Rotor: **12177, 12786**

Pojemnik/Bucket: **13174, 13178**

Probówka/Tube: **15054, 15119, 15120, 15419**

**14156**

Wkładka/Adaptor na probówki/for tubes  
8x15/10 ml(hermetyczny/hermetic)

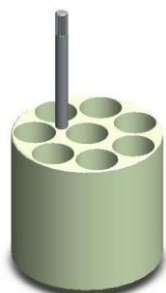

φ61/17x113

Wirówka/Centrifuge:

**351,352, 380**

Wirnik/Rotor: **12177, 12786**

Pojemnik/Bucket: **13174, 13178**

Probówka/Tube: **15046, 15048, 15118**

**14157**

Wkładka/Adaptor na probówki/for tubes  
4x15 ml  
(okrągłodenna/round-bottom)



φ61/17x120

Wirówka/Centrifuge:

**351,352, 380**

Wirnik/Rotor: **12177, 12786**

Pojemnik/Bucket: **13174, 13178**

Probówka/Tube: **15053, 15118, TechnoPlasticProducts AG nr kat. 91106**

**14158**

Wkładka/Adaptor na probówki/for tubes  
12x2,0/1,5 ml

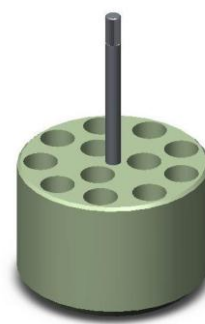

φ61/11x43

Wirówka/Centrifuge:

**351,352, 380**

Wirnik/Rotor: **12177, 12786**

Pojemnik/Bucket: **13174, 13178**

Probówka/Tube: **15011, 15015, 15128**

**14159**

Wkładka/Adaptor na probówki/for tubes  
50 ml



φ45/35,5x100

Wirówka/Centrifuge:

**351,352, 380**

Wirnik/Rotor: **12177, 12786, 12830**

Pojemnik/Bucket: **13174, 13178, 13831, 13833**

Wkładka/Adaptor: **14151, 15841, 14850**  
Probówka/Tube: **15116**

**14160**

Wkładka/Adaptor na  
probówki/for tubes  
**3x30/25ml**



φ61/25,5x100

Wirówka/Centrifuge: **351,352, 380**  
Wirnik/Rotor: **12177, 12786**  
Pojemnik/Bucket: **13174, 13178**  
Probówka/Tube: **15055, 15056, 15117**

**14169**

Wkładka/Adaptor na  
probówki/for tubes  
**8x4 ml**



φ56/13,5x81

Wirówka/Centrifuge: **223e, 251, 260**  
Wirnik/Rotor: **12232**  
Pojemnik/Bucket: **13233**  
Probówka/Tube: **15120, 15419, Monovette**

**14175**

podkładka pod  
butelki/insert for bottles  
**250 ml**

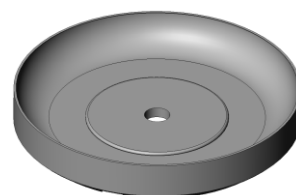

φ62

Wirówka/Centrifuge: **351,352, 380**  
Wirnik/Rotor: **11177, 12177, 12786, 12830**  
Pojemnik/Bucket: **13174, 13178/c**  
Probówka/Tube: **15175, 15176**

**14181**

Wkładka/Adaptor na  
probówki/for tubes **5x7 ml**

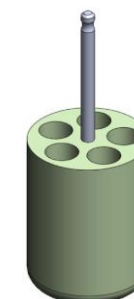

φ44,5/12,5x100

Wirówka/Centrifuge: **223e, 251, 260, 351e, 351,352**  
Wirnik/Rotor: **12183, 12436**  
Pojemnik/Bucket: **13182, 13184, 13593**  
Probówka/Tube: **15119**

**14186**

Wkładka/Adaptor na  
probówki/for tubes  
**4x7 ml**

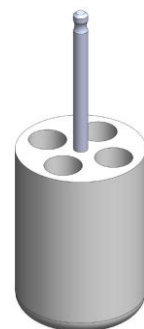

φ44,5/13,1x112

Wirówka/Centrifuge: **223e, 251, 260, 351e, 351,352**  
Wirnik/Rotor: **12183, 12436**  
Pojemnik/Bucket: **13182, 13184/c, 13593**  
Probówka/Tube: **15054, 15119, 15120, 15419**

**14187**

Wkładka/Adaptor na  
probówki/for tubes  
**4x15/10 ml**

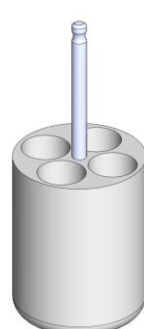

φ44,5/16,5x100

Wirówka/Centrifuge: **223e, 251, 260, 351e, 351,352**  
Wirnik/Rotor: **12183, 12436**  
Pojemnik/Bucket: **13182, 13184/c, 13593**  
Probówka/Tube: **15118 (korek max φ17,8 x100)**

**14188**

podkładka pod probówki  
**100/50/30/25 ml**

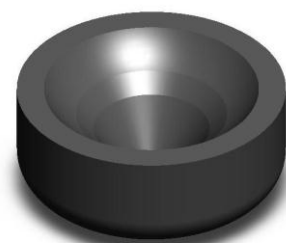

φ44,5

Wirówka/Centrifuge: **223e, 251, 260, 351e, 351,352**  
Wirnik/Rotor: **12183, 11718, 12436**  
Pojemnik/Bucket: **13182, 13184, 13593, 13719**  
Wkładka/Adaptor: **14841, 14850**  
Probówka/Tube: **15052, 15115, 15116, 15117**

**14189**

Wkładka/Adaptor na  
probówki/for tubes  
**50 ml Falcon**



φ44,5/30x120

Wirówka/Centrifuge: **223e, 251, 260, 351e, 351,352**  
Wirnik/Rotor: **12183, 11718, 12436**  
Pojemnik/Bucket: **13182, 13184, 13593, 13719**  
Probówka/Tube: **15052**

**14189c**

Wkładka/Adaptor na  
probówki/for tubes  
**50 ml Falcon**



φ44,5/30x120

Wirówka/Centrifuge: **223e, 251, 260, 351e, 351,352**  
Wirnik/Rotor: **12183, 11718, 12436**  
Pojemnik/Bucket: **13182, 13184, 13593, 13719**  
Probówka/Tube: **15052**

**14190**

Wkładka/Adaptor na  
probówki/for tubes  
**30 ml**

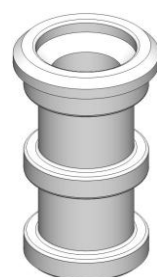

φ44,5/25,5x102

Wirówka/Centrifuge: **223e, 251, 260, 351e, 351,352**  
Wirnik/Rotor: **12183, 11718, 12436**  
Pojemnik/Bucket: **13182, 13184, 13593, 13719**  
Probówka/Tube: **15055, 15117**

**14190c**

Wkładka/Adaptor na  
probówki/for tubes  
**30 ml**

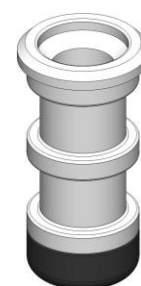

φ44,5/25,5x102

Wirówka/Centrifuge: **223e, 251, 260, 351e, 351,352**  
Wirnik/Rotor: **12183, 11718, 12436**  
Pojemnik/Bucket: **13182, 13184, 13593, 13719**  
Probówka/Tube: **15055, 15117**

**14192**

Wkładka/Adaptor na  
probówki/for tubes  
**50 ml**

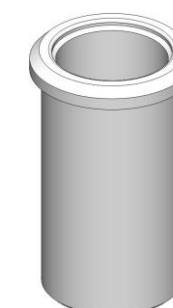

φ44,5/35,5x100

Wirówka/Centrifuge: **223e, 251, 260, 351e, 351,352**  
Wirnik/Rotor: **12183, 11718, 12436**  
Pojemnik/Bucket: **13182, 13184, 13593, 13719**  
Probówka/Tube: **150116**

**14192c**

Wkładka/Adaptor na probówki/for tubes 50 ml



φ44,5/35,5x100

Wirówka/Centrifuge: **223e, 251, 260, 351e, 351,352**  
Wirnik/Rotor: **12183, 11718, 12436**  
Pojemnik/Bucket: **13182, 13184, 13593, 13719**  
Probówka/Tube: **150116**

**14196**

podkładka pod probówki PP 100 ml



φ44,5

Wirówka/Centrifuge: **223e, 251, 260, 351e, 351,352**  
Wirnik/Rotor: **12183, 11718, 12436**  
Pojemnik/Bucket: **13182, 13184, 13593, 13719**  
Probówka/Tube: **15040**

**14224**

Wkładka/Adaptor na/for probówki/tubes płaskodenne/flat-bottom 30ml



Wirówka/Centrifuge: **223e, 251, 260, 351e, 351, 352**  
Wirnik/Rotor: **12183, 12436, 11718**  
Pojemnik/Bucket: **13182, 13593, 13719**  
Probówka/Tube: **15055, 15056, 15222, 15223,**

**14235**

Wkładka/Adaptor na probówki/for tubes 12x5 ml

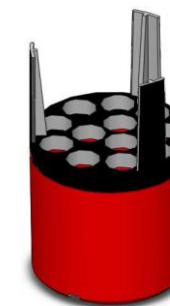

φ56,5/12,5x85

Wirówka/Centrifuge: **223e, 251, 260**  
Wirnik/Rotor: **12232**  
Pojemnik/Bucket: **13233**  
Probówka/Tube: **15120, 15419**

**14238**

Wkładka/Adaptor na probówki/for tubes 7x10 ml (niska(short))



φ56,5/17x91

Wirówka/Centrifuge: **223e, 251, 260**  
Wirnik/Rotor: **12232**  
Pojemnik/Bucket: **13233**  
Probówka/Tube: **Monovette**

**14239**

Wkładka/Adaptor na probówki/for tubes 7x5 ml (niska(short))

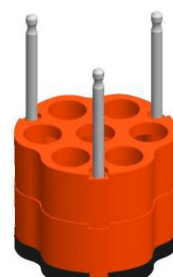

φ56,5/13,5x91

Wirówka/Centrifuge: **223e, 251, 260**  
Wirnik/Rotor: **12232**  
Pojemnik/Bucket: **13233**  
Probówka/Tube: **Monovette**

**14240**

Wkładka/Adaptor na probówki/for tubes 9x2,0/1,5 ml

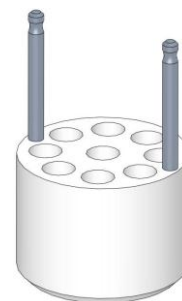

φ56,5/11x41,2

Wirówka/Centrifuge: **223e, 251, 260**  
Wirnik/Rotor: **12232**  
Pojemnik/Bucket: **13233**  
Probówka/Tube: **15011, 15015, 15128**

**14242**

Wkładka/Adaptor na probówki/for tubes 12x1,2 ml S-Monovette (niska/short)



φ56,5/9x82,3

Wirówka/Centrifuge: **223e, 251, 260**  
Wirnik/Rotor: **12232**  
Pojemnik/Bucket: **13233**  
Probówka/Tube: **15016**

**14248**

Wkładka/Adaptor na probówki/for tubes 30/25 ml



φ29,8/26x102

Wirówka/Centrifuge: **223e, 251, 260, 351e, 351,352, 380**  
Wirnik/Rotor: **11211, 11213, 11254, 11333, 11744, 11746, 11780, 12183, 12485**  
Pojemnik/Bucket: **13249, 13250, 13266, 13267, 13275, 13276**  
Probówka/Tube: **15055, 15117**

**14255**

Wkładka/Adaptor na probówki/for tubes 7 ml



φ25/13x100

Wirówka/Centrifuge: **223e, 251, 260, 351e, 351,352**  
Wirnik/Rotor: **11257, 11332, 11742, 11743**  
Pojemnik/Bucket: **13329**  
Probówka/Tube: **15054, 15119**

**14256**

Wkładka/Adaptor na probówki/for tubes 15/10 ml



φ25/17x113

Wirówka/Centrifuge: **223e, 251, 260, 351e, 351,352**  
Wirnik/Rotor: **11257, 11332, 11742, 11743**  
Pojemnik/Bucket: **13329**  
Probówka/Tube: **15046, 15048, 15053, 15118**

**14441**

Wkładka/Adaptor na probówki/for tubes 12x7/6 ml

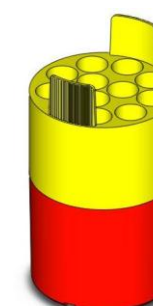

φ56,5xφ12,3x100

Wirówka/Centrifuge: **351e, 351,352**  
Wirnik/Rotor: **12436**  
Pojemnik/Bucket: **13437, 13438**  
Probówka/Tube: **15119**

**14443**

Wkładka/Adaptor na  
próbówki/for tubes  
2x25 ml



φ56,5/25,5x100

Wirówka/Centrifuge: **351e,**  
**351,352**  
Wirnik/Rotor: **12436**  
Pojemnik/Bucket: **13437,**  
**13438**  
Probówka/Tube: **15055,**  
**15117**

**14446**

Wkładka/Adaptor na  
próbówki/for tubes  
12x5 ml

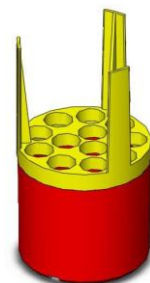

φ56,5/12,5x85

Wirówka/Centrifuge: **351e,**  
**351,352**  
Wirnik/Rotor: **12436**  
Pojemnik/Bucket: **13437,**  
**13438**  
Probówka/Tube: **15120,**  
**15419**

**14447a**

Wkładka/Adaptor na  
próbówki/for tubes **12x1,2**  
ml S-Monovette



φ56,5/9x82,3

Wirówka/Centrifuge: **351e,**  
**351,352**  
Wirnik/Rotor: **12436**  
Pojemnik/Bucket: **13437,**  
**13438/c**  
Probówka/Tube: **15016**

**14449**

Wkładka/Adaptor na  
próbówki/for tubes **4x12**  
ml Monovette

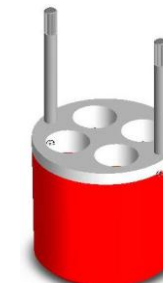

φ56,5/17,1x105

Wirówka/Centrifuge: **351e,**  
**351,352**  
Wirnik/Rotor: **12436**  
Pojemnik/Bucket: **13437,**  
**13438**  
Probówka/Tube: **15046,**  
**15053, 15118**

**14450**

Wkładka/Adaptor na  
próbówki/for tubes  
9x2,0/1,5 ml

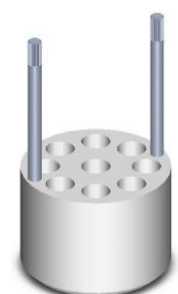

φ56,5/11x41,2

Wirówka/Centrifuge: **351e,**  
**351,352**  
Wirnik/Rotor: **12436**  
Pojemnik/Bucket: **13437,**  
**13438**  
Probówka/Tube: **15011,**  
**15015, 15128**

**14505**

Wkładka/Adaptor na/for  
butelki/bottles Babcock  
(Gerber 5406)

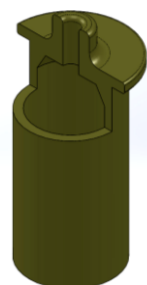

Wirówka/Centrifuge: **351**  
Wirnik/Rotor: **11503**  
Pojemnik/Bucket: **13504**  
Probówka/Tube:  
butelka/bottles Babcock  
(Gerber 5406)

**14584**

Wkładka/Adaptor na  
próbówki/for tubes **4xCPT**  
(φ16x130 mm)

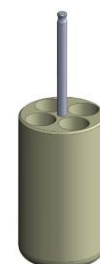

φ44,5/16x130

Wirówka/Centrifuge:  
**351,352**  
Wirnik/Rotor: **12582**  
Pojemnik/Bucket: **13583**  
Probówka/Tube: **CPT**  
(φ16x130)

**14793**

Wkładka/Adaptor na  
próbówki/for tubes **13x15**  
ml Falcon

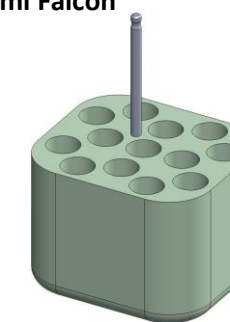

83x95/φ17x120

Wirówka/Centrifuge: **380**  
Wirnik/Rotor: **12830**  
Pojemnik/Bucket: **13831**  
Probówka/Tube: **15054,**  
**15119, 15120, 15419**

Wkładka/Adaptor do próbek z  
korkiem max φ21.

**14794**

Wkładka/Adaptor na  
naczynia  
ASTM długości 160 mm

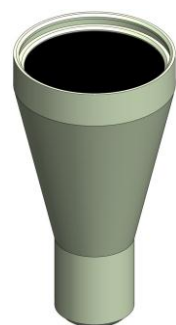

Wirówka/Centrifuge: **380**  
Wirnik/Rotor: **12791**  
Pojemnik/Bucket: **13792/c**  
Probówka/Tube: **15797**

**14795**

Wkładka/Adaptor na  
naczynia  
ASTM dł./length 167 mm



Wirówka/Centrifuge: **380**  
Wirnik/Rotor: **12791**  
Pojemnik/Bucket: **13792/c**  
Probówka/Tube: **15796**



**14836**

Wkładka/Adaptor na  
probówki/for tubes  
**24x5/6,7 ml**

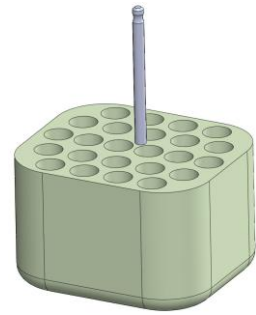

83x95/φ13,1x100

Wirówka/Centrifuge: **380**  
Wirnik/Rotor: **12830**  
Pojemnik/Bucket: **13831**  
Probówka/Tube: **15054,**  
**15119, 15120, 15419**

Wkładka do probówek z korkiem  
max φ15 dł 120.

Adaptor for tubes with cap max  
φ15 dl/length 120.

**14837**

Wkładka/Adaptor na  
probówki/for tubes  
**16x15/10/6 ml**

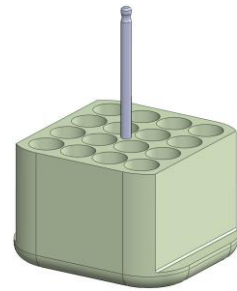

83x95/φ17x113

Wirówka/Centrifuge: **380**  
Wirnik/Rotor: **12830**  
Pojemnik/Bucket: **13831**  
Probówka/Tube: **15046,**  
**15048, 15053, 15118, 15121**

**14838**

Wkładka/Adaptor na  
probówki/for tubes **12x15**  
**ml Falcon**

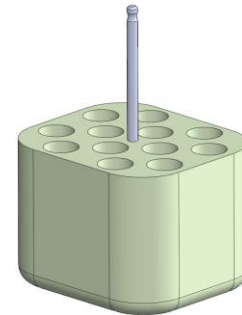

83x95/φ17x120

Wirówka/Centrifuge: **380**  
Wirnik/Rotor: **12830**  
Pojemnik/Bucket: **13831**  
Probówka/Tube: **15050**

Wkładka/Adaptor do probówek z  
korkiem max φ23.

Adaptor for tubes with cap max  
φ23.

**14839**

Wkładka/Adaptor na  
probówki/for tubes  
**8x30 ml**

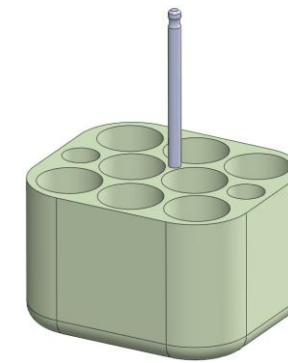

83x95/φ26x102

Wirówka/Centrifuge: **380**  
Wirnik/Rotor: **12830**  
Pojemnik/Bucket: **13831**  
Probówka/Tube: **15055,**  
**15056, 15117, 15424**

**14840**

Wkładka/Adaptor na  
probówki/for tubes  
**5x50 ml Falcon**

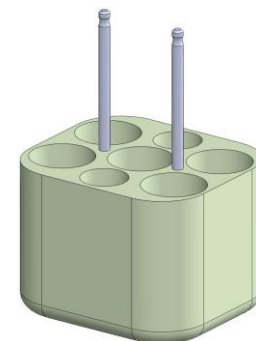

83x95/φ30x120

Wirówka/Centrifuge: **380**  
Wirnik/Rotor: **12830**  
Pojemnik/Bucket: **13831**  
Probówka/Tube: **15052**

**14841**

Wkładka/Adaptor na  
probówki/for tubes **2x100**  
**ml**

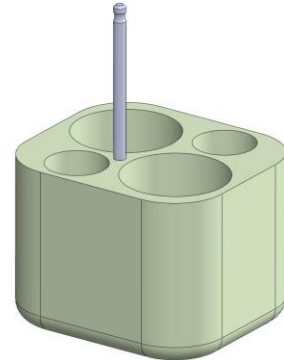

83x95/φ45x103

Wirówka/Centrifuge: **380**  
Wirnik/Rotor: **12830**  
Pojemnik/Bucket: **13831**  
Probówka/Tube: **15040,**  
**15115**

**14842**

Wkładka/Adaptor na  
butelki/for bottles  
**250 ml**

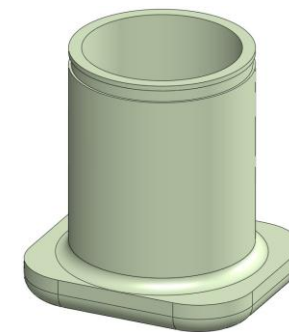

83x95/φ62x135

Wirówka/Centrifuge: **380**  
Wirnik/Rotor: **12830**  
Pojemnik/Bucket: **13831**  
Wkładka/Adaptor: **14017,**  
**14175**  
Probówka/Tube: **15017,**  
**15175, 15176**

**14844**

Wkładka/Adaptor na  
probówki/for tubes  
**26x2,0/1,5 ml**

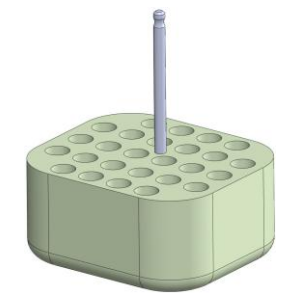

83x95/φ11x41,2

Wirówka/Centrifuge: **380**  
Wirnik/Rotor: **12830**  
Pojemnik/Bucket: **13831**  
Probówka/Tube: **15011,**  
**15015, 15128**

**14845**

Wkładka/Adaptor na  
probówki/for tubes  
**18x5 ml**

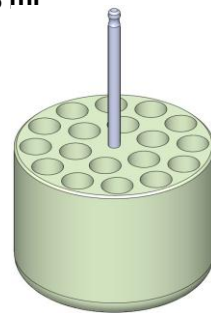

φ84/φ13,5x95

Wirówka/Centrifuge: **380**  
Wirnik/Rotor: **12830**  
Pojemnik/Bucket: **13833**  
Probówka/Tube: **15054,**  
**15119, 15120, 15419**

**14846**

Wkładka/Adaptor na  
probówki/for tubes  
**12x15/10 ml**

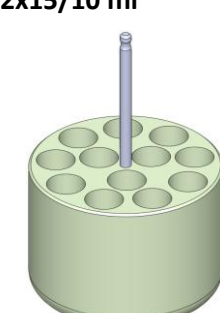

φ84/φ17x113

Wirówka/Centrifuge: **380**  
Wirnik/Rotor: **12830**  
Pojemnik/Bucket: **13833**  
Probówka/Tube: **15046,**  
**15048, 15053, 15118, 15121**

**14847**

Wkładka/Adaptor na  
probówki/for tubes **12x15**  
**ml Falcon**

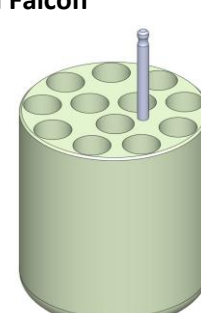

φ84/φ17x120

Wirówka/Centrifuge: **380**  
Wirnik/Rotor: **12830**  
Pojemnik/Bucket: **13833**  
Probówka/Tube: **15050**

**14848**

Wkładka/Adaptor na  
probówki/for tubes  
**5x30**

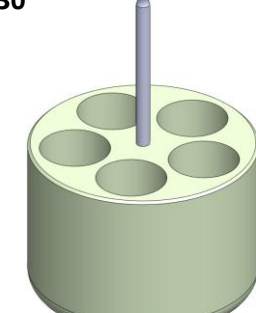

φ84/φ26x102

Wirówka/Centrifuge: **380**  
Wirnik/Rotor: **12830**  
Pojemnik/Bucket: **13833**  
Probówka/Tube: **15055,**  
**15056, 15117, 15424**

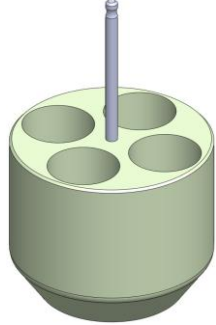
**14849**Wkładka/Adaptor na  
próbówki/for tubes  
**4x50 ml Falcon**

φ84/φ30x120

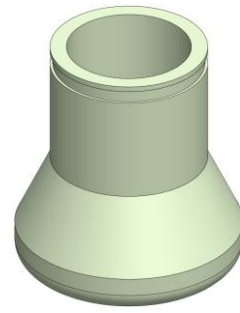
Wirówka/Centrifuge: **380**  
Wirnik/Rotor: **12830**  
Pojemnik/Bucket: **13833**  
Probówka/Tube: **15052****14850**Wkładka/Adaptor na  
próbówki/for tubes  
**100 ml**

φ84/φ45x103

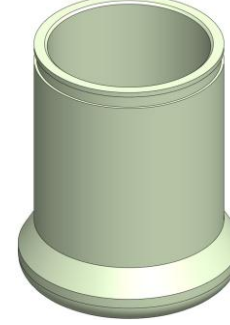
Wirówka/Centrifuge: **380**  
Wirnik/Rotor: **12830**  
Pojemnik/Bucket: **13833**  
Probówka/Tube: **15040,**  
**15115****14851**Wkładka/Adaptor na  
butelki/for bottles  
**250 ml**

φ84/φ62x135

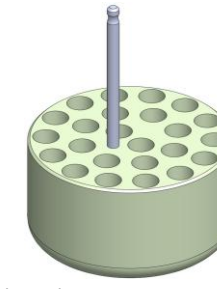
Wirówka/Centrifuge: **380**  
Wirnik/Rotor: **12830**  
Pojemnik/Bucket: **13833**  
Wkładka/Adaptor: **14017,**  
**14175**  
Probówka/Tube: **15017,**  
**15175, 15176****14853**Wkładka/Adaptor na  
próbówki/for tubes  
**24x2,0/1,5 ml**

φ84/φ11x41,2

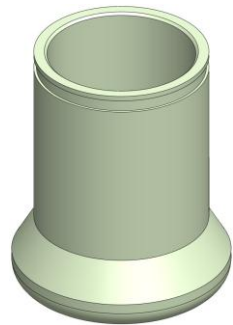
Wirówka/Centrifuge: **380**  
Wirnik/Rotor: **12830**  
Pojemnik/Bucket: **13833**  
Probówka/Tube: **15011,**  
**15015, 15128****14854**Wkładka/Adaptor na  
butelki/for bottles  
**200 ml**

φ84/φ57x113

Wirówka/Centrifuge: **380**  
Wirnik/Rotor: **12830**  
Pojemnik/Bucket: **13833**  
Probówka/Tube: **15440****14855**Wkładka/Adaptor na  
próbówki/for tubes  
**50 ml Falcon**

φ38/φ30x120

Wirówka/Centrifuge:  
**351,352, 380**  
Wirnik/Rotor: **11778, 11586**  
Pojemnik/Bucket: **13587**  
Probówka/Tube: **15052****14856**Wkładka/Adaptor na  
próbówki/for tubes  
**15 ml Falcon**

φ38/φ17x120

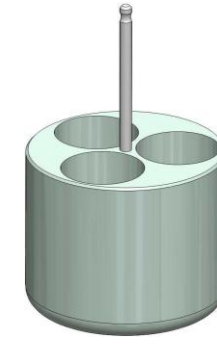
Wirówka/Centrifuge:  
**351,352, 380**  
Wirnik/Rotor: **11778, 11586**  
Pojemnik/Bucket: **13587**  
Probówka/Tube: **15050****14859**Wkładka/Adaptor na  
próbówki/for tubes  
**3x50 ml szklane**

φ84/φ35x100

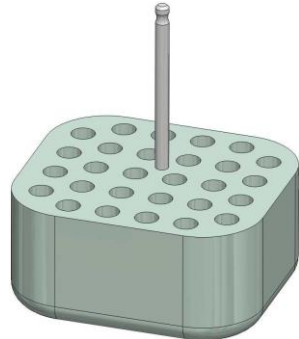
Wirówka/Centrifuge: **380**  
Wirnik/Rotor: **12830**  
Pojemnik/Bucket: **13833**  
Probówka/Tube: **15116****14860**Wkładka/Adaptor na  
próbówki/for tubes  
**28x1,2 ml S-Monovette**

83x95/φ9x82,3

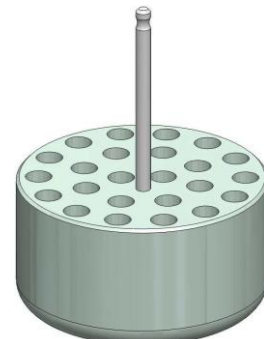
Wirówka/Centrifuge: **380**  
Wirnik/Rotor: **12830**  
Pojemnik/Bucket: **13831**  
Probówka/Tube: **15016****14861**Wkładka/Adaptor na  
próbówki/for tubes  
**24x1,2 ml S-Monovette**



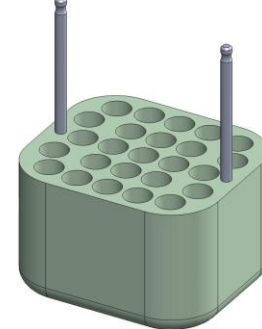





















φ38/φ9x82,3



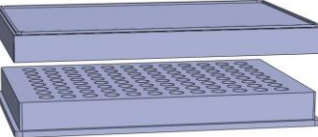
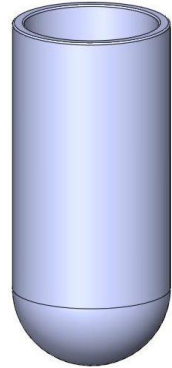





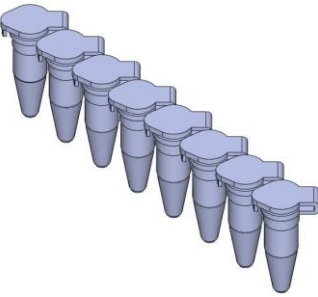



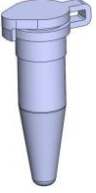

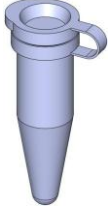

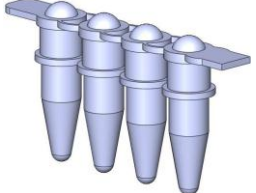
Wirówka/Centrifuge: **380**  
Wirnik/Rotor: **12830**  
Pojemnik/Bucket: **13833**  
Probówka/Tube: **15016****14862**Wkładka/Adaptor na  
próbówki/for tubes  
**25x5 ml**

83x95/φ13,1x100

Wirówka/Centrifuge: **380**  
Wirnik/Rotor: **12830**  
Pojemnik/Bucket: **13831**  
Probówka/Tube: **15119,**  
**15120, 15419, 15054**Wkładka/Adaptor do probówek z  
korkiem max φ15 dł 110.



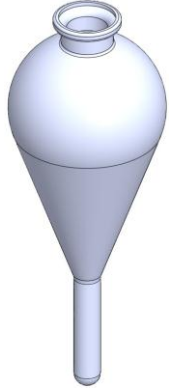







<p><b>15011</b>            Probówka/Tube PP 2 ml            okrągłodenna/round-            bottom</p>  <p>φ10,8x40mm</p>	<p><b>15015</b>            Probówka/Tube PP 2 ml            dno stożkowe</p>  <p>φ10,8x41,2mm</p>	<p><b>15016</b>            Probówka/Tube PP 1,2            ml s-Monovette</p>  <p>φ8,8/13,3x82,3mm</p>	<p><b>15017</b>            Butelka/Bottle PC 250 ml            okrągłodenna/round-            bottom</p>  <p>φ61x126mm (z podkl./inc.            insert)</p>	<p><b>15040</b>            Probówka/Tube PP 100            ml            z pokrywką/with lid</p>  <p>φ44,7/47x103,7mm</p>	<p><b>15046</b>            Probówka/Tube PP 14 ml            z pokrywką/with lid</p>  <p>φ16,8/17,7x113,7mm</p>	<p><b>15048</b>            Probówka/Tube PP 15 ml            NALGENE</p>  <p>φ16x113mm</p>	<p><b>15050</b>            Probówka/Tube PP 15 ml            typu FALCON (Sarstedt) z            pokrywką/with lid</p>  <p>φ17/21x120mm</p>	<p><b>15051</b>            Probówka/Tube PP 50 ml            NALGENE</p>  <p>φ28,8x106,7mm</p>
<p><b>15052</b>            Probówka/Tube PP 50 ml            FALCON z pokrywką/with            lid</p>  <p>φ29,5/34x117mm</p>	<p><b>15053</b>            Probówka/Tube PP 10 ml            z pokrywką/with lid</p>  <p>φ16/19x100mm</p>	<p><b>15054</b>            Probówka/Tube PP 6 ml            z pokrywką/with lid</p>  <p>φ11,7/13,5x95mm</p>	<p><b>15055</b>            Probówka/Tube PP 30 ml            z pokrywką/with lid</p>  <p>φ24,9x103mm</p>	<p><b>15056</b>            Probówka z PC 30 ml            z pokrywką/with lid            NALGENE</p>  <p>φ25,5x94mm</p>	<p><b>15067</b>            Probówka z PC 85 ml            z pokrywką/with lid            NALGENE</p>  <p>φ37,8x106mm</p>	<p><b>15098</b>            Zatyczki do kapilar/            Stopper for capillary            tube</p> 	<p><b>15100</b>            Kapilary szklane/Glass            capillary tubes            heparynowane/hepariniz            ed</p>  <p>1,4x75mm, 37μl</p>	<p><b>15101</b>            Kapilary szklane/Glass            capillary tubes            heparynowane/hepariniz            ed</p>  <p>1,3x50mm, 19μl</p>
<p><b>15102</b>            Płytkę titracyjną/MTP            z pokrywką/with lid <b>plate</b></p>  <p>85,5x127mm</p>	<p><b>15115</b>            Probówka szklana/Tube            (glass)            100 ml</p>  <p>φ45x100mm</p>	<p><b>15116</b>            Probówka szklana/Tube            (glass)            50 ml</p>  <p>φ35x100mm</p>	<p><b>15117</b>            Probówka szklana/Tube            (glass)            25 ml</p>  <p>φ25x100mm</p>	<p><b>15118</b>            Probówka szklana/Tube            (glass)            10 ml</p>  <p>φ16x100mm</p>	<p><b>15119</b>            Probówka szklana/Tube            (glass) 7 ml</p>  <p>φ12x100mm</p>	<p><b>15120</b>            Probówka szklana/Tube            (glass) 5 ml</p>  <p>φ12x75mm</p>	<p><b>15121</b>            Probówka/Tube PP 10 ml            z pokrywką/with lid</p>  <p>φ17/19x70mm</p>	<p><b>15122</b>            Probówka PCR            szeregową/Tube PCR            stripe 8x0,2 ml</p>  <p>φ6x21mm</p>

<p><b>15123</b>            Probówka/Tube PP 2,2 ml            z pokrywką/with lid            do wkładek CYTO</p>  <p>φ10,8x43mm</p>	<p><b>15124</b>            Probówka/Tube PP 0,4 ml            z pokrywką/with lid</p>  <p>φ5,7x46mm</p>	<p><b>15125</b>            Probówka/Tube PP 0,2 ml PCR</p>  <p>φ6x21mm</p>	<p><b>15127</b>            Probówka/Tube PP 0,5 ml            z pokrywką/with lid</p>  <p>φ7,8x30mm</p>	<p><b>15128</b>            Probówka/Tube PP 1,5 ml            z pokrywką/with lid</p>  <p>φ10,8x39mm</p>	<p><b>15130</b>            Probówka PCR szeregowo/Tube PCR stripe 8x0,2 ml</p>  <p>φ6x21mm</p>	<p><b>15131</b>            Probówka PCR szeregowo/Tube PCR stripe 4x0,2 ml</p>  <p>φ6x21mm</p>	<p><b>15175</b>            Butelka/Bottle PP 250 ml            HEROLAB 253421</p>  <p>φ61x126mm (z podkł./inc. insert)</p>	<p><b>15176</b>            Butelka/Bottle PC 250 ml            HEROLAB 253401</p>  <p>φ61x126mm (z podkł./inc. insert)</p>
<p><b>15222</b>            Probówka/Tube 30ml PP</p>  <p>φ25,1/31x94mm</p>	<p><b>15223</b>            Probówka/Tube 30ml PS</p>  <p>φ25,1/31x94mm</p>	<p><b>15419</b>            Probówka/Tube PP 5 ml z korkiem / with cap</p>  <p>φ12x85mm</p>	<p><b>15424</b>            Probówka/Tube PP 30 ml z pokrywką/with lid</p>  <p>φ25,5x94mm</p>	<p><b>15440</b>            Probówka/Tube PP 200 ml z pokrywką/with lid</p>  <p>φ56,5x113mm</p>	<p><b>15796</b>            Pojemnik/Bucket szklany/glass ASTM dł./length 167 mm</p> 	<p><b>15797</b>            Pojemnik/Bucket szklany/glass ASTM dł./length 160 mm</p> 	<p><b>15852</b>            Butelka/Bottle 400 ml</p>  <p>φ85x135mm</p>	







Herolab – próbki i butelki

Herolab – tubes and bottles

Nr kat.	Nazwa wyrobu (cennik)	Wchodzi do: MPW -	Poj. nom. (ml)	Poj. fakt. (ml)	Wymiary (mm)	Materiał	RPM (max.)	RCF (max.)	Ilość w op.	
Cat. No.	Name (price list)	Fits in: MPW -	Nominal Vol. (ml)	Filling Vol. (ml)	Dimensions (mm)	Material and Form	tested	tested	Units per pack	
25 32 41	80ml PC - kpl./set (10 szt./pcs)	351, 380	80	73,1	35 x 105	PC - AOR	20,000	50,086	10	
25 32 21	50 ml PF- kpl./set (2 szt./pcsi)	223e, 251, 260, 351, 380	50	42,6	29 x 103	PF - AOR	18,000	39,121	2	
25 29 61	30ml PPCO - kpl./set (10 szt./pcs)	223e, 251, 260, 351, 351e, 380	30	25,9	25 x 92	PPCO(PA) - AOR	24,000	64,397	10	
25 22 30	4,5 ml PP-RB - kpl./set (1000 szt./pcs)	54, 56, 223e, 251, 260, 351, 351e, 380	4,5	4,5	12 x 75	PP – RB	20,000	36,000	1000	
25 33 30	100 ml PP-RB - kpl./set (10 szt./pcs)	223e, 251, 260, 380	100	110	40 x 115	PC-RB/G	6,000	5,635	10	
25 29 51	30 ml PC-AOR WITH SCREW CAP - kpl./set (10 szt./pcs)	223e, 251, 260, 351e351, 380	30	27,9	25 x 92	PC - AOR	24,000	64,397	10	
25 24 51	10 ml PF-AOR WITH SCREW CAP - kpl./set (2 szt./pcs)	54, 56, 223e, 251, 260, 351e, 351,380	10	9,4	16 x 80	PF - AOR	20,000	40,250	2	
25 24 11	10 ml PPCO-AOR WITH SCREW CAP - kpl./set (10 szt./pcs)	54, 56, 223e, 251, 260, 351, 351e, 380	10	8,9	16 x 80	PPCO(PA) - AOR	24,000	57,960	10	
25 46 00	pokrywa do 50 ml PP - kpl./set (10 szt./pcs)	351, 380	cap		do 50 ml for 50 ml	PP			10	

## Herolab – próbówki i butelki

## Herolab – tubes and bottles

<b>25 10 20</b>	5 ml B (szkło) - kpl./set 10 szt./pcs	223e,251,260,351e, 351, 380	<b>5</b>	4,8	12 x 75	Borex Glass, RB	5,000	6,000* horizont	10	
<b>25 11 10</b>	30 ml B (szkło) - kpl./set (10 szt./pcs)	223e, 251, 260, 351, 351e, 380	<b>30</b>	25	24 x 105	Borex Glass, RB	5,000	12,500 * horizont	10	
<b>25 22 00</b>	5 ml PS-RB - kpl./set (1000 szt./pcs)	54, 56, 223e, 251, 260, 351, 351e, 380	<b>5</b>	4,5	12 x 75	PS - RB	5,000	2,500	1000	
<b>25 34 21</b>	250 ml PPCO-FB WITH SCREW CAP - kpl./set (6 szt./pcs)	351, 380	<b>250</b>	225,1	62 x 122	PPCO - FB	14,400	33,847	6	
<b>25 33 73</b>	200ml PPCO FB WITH SCREW CAP - kpl./set (6 szt./pcs)	351, 351e, 380	<b>200</b>	168,4	56 x 112	PP – FB/W	10,000	16,323	6	
<b>25 31 60</b>	50 ml PPCO RB/FL - kpl./set (10 szt./pcs)	223e, 251, 260,351,380	<b>50</b>	42,1	29 x 103	PPCO – RB / FL	24,000	69,549	10	
<b>25 32 49</b>	80 ml PF - kpl./set (2 szt./pcsi)	351, 380	<b>80</b>	73	38 x 105	PF - AOR	15,000	28,174	2	

**AB**—Cellulose Acetate Butyrate, **PY**—Pyrex®, **PC**—Polycarbonate, **PP**—Polypropylene, **PS**—Polysulfone, **PA**—Polyallomer, **PF** - Polyflor, **CO**—Corex® Glass, **RB** - okrągłodenna, **FB** - płaskie dno, **FL** - Flange/Rim